

OPERATING AND SERVICE MANUAL

HP 5384A and HP 5385A Frequency Counters

SERIAL PREFIX: 2436A

This manual applies to Serial prefix 2436A, unless accompanied by a Manual change Sheet indicating otherwise.

© Copyright HEWLETT-PACKARD COMPANY 1985
5301 STEVENS CREEK BOULEVARD, SANTA CLARA, CA 95051

MANUAL PART NUMBER 05384-90006
Microfiche Part Number 05384-90007

Printed: FEB 1987



**HEWLETT
PACKARD**

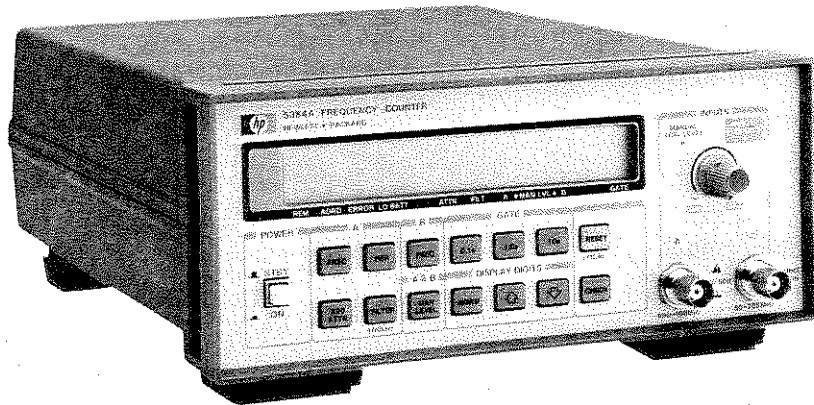

Model HP 5384A

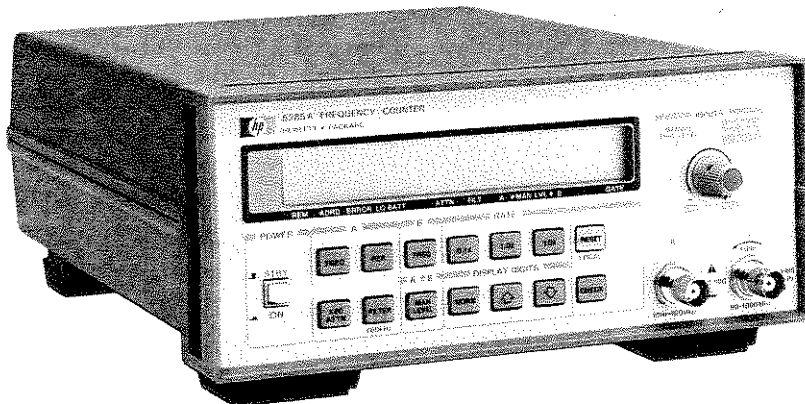

Model HP 5385A

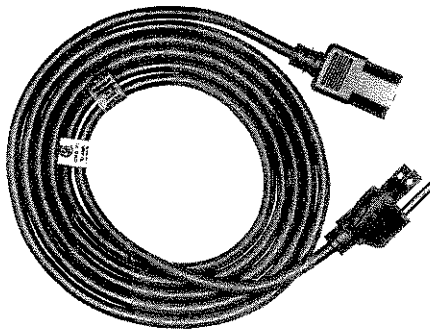

Power Cord

Figure 1-1. Models HP 5384A and HP 5385A Frequency Counters and Accessories

SECTION I GENERAL INFORMATION

1-1. INTRODUCTION

1-2. This manual provides you with information pertaining to the installation, operating, programming, performance tests, adjustments, and maintenance of the Hewlett-Packard Models 5384A and 5385A Frequency Counters, shown in *Figure 1-1*.

1-3. MANUAL SUMMARY

1-4. The manual is divided into eight sections, each covering a particular topic for the operation of the HP 5384A and HP 5385A Frequency Counters. The topics by section number are:

Section	Topic
I	General Information
II	Installation
III	Operation and Programming
IV	Performance Tests
V	Adjustments
VI	Replaceable Parts
VII	Manual Changes
VIII	Service

1-5. SPECIFICATIONS

1-6. The instrument specifications and option specifications are listed in *Table 1-1*. These specifications are performance standards or limits against which the instrument may be tested.

1-7. SAFETY CONSIDERATIONS

1-8. This is a Safety Class I instrument. This instrument has been designed and tested according to international safety requirements.

1-9. This manual contains information, cautions, and warnings which must be followed by operating and service personnel to ensure safe operation and to retain the instrument in safe condition.

1-10. DESCRIPTION

1-11. The Hewlett-Packard Models 5384A and 5385A are frequency counters that make frequency and period measurements. The HP 5384A has a frequency range of 10 Hz to 225 MHz, and the HP 5385A has a frequency range of 10 Hz to 1000 MHz. Both counters are microcomputer based instruments with a data bus port for remote operation through either HP-IL or HP-IB.

1-12. Both counters have "A" and "B" input channels with BNC type connectors.

1-13. Above the "A" and "B" input connectors is a dual purpose control that allows you to either set the trigger level of Channel A or adjust the input attenuation of Channel B.

1-14. A 100 kHz low pass filter can be toggled in or out of the Channel A signal path on either counter.

1-15. Measurement display and mode annunciators are shown on a 12-character alphanumeric liquid crystal display (LCD). Frequency and period measurements are displayed in engineering format, with three alpha characters used to designate units, e.g., MHz. The display will also give you brief messages and diagnostic prompts.

1-16. The HP 5384A and HP 5385A are designed so you may either rack mount or stack them.

1-17. A 10 MHz reference oscillator output is included in both counters. The connector for the 10 MHz output may also be used as an external 10 MHz reference oscillator input connection.

1-18. Option 001 is a temperature compensated crystal oscillator (TCXO). The TCXO is an option in the HP 5384A and standard in the HP 5385A.

1-19. A jack for connecting external dc power is provided on the rear panel and Option 005 battery pack can be installed to provide mobility.

1-20. Option 003 is the Hewlett-Packard Interface Loop (HP-IL) for remote control of the counters by battery operated controllers such as the HP41C/CV hand held controller.

1-21. Option 004 is an ovenized oscillator that provides a high stability time base giving substantially higher accuracy over variations in time and temperature.

1-22. Option 005 is a battery pack that provides portable operation of the HP 5384A or HP 5385A.

1-23. HP-IB is the Hewlett-Packard Interface Bus for remote control of the counters by computers and controllers. It is a standard feature in the instrument.

1-24. The HP-IB, (Hewlett-Packard Interface Bus) is Hewlett-Packard's implementation of IEEE Standard 488-1978 and ANSI Standard MC 1.1. HP-IB is a high-speed parallel interface bus. All devices on the bus are capable of being addressed at one time. However, only one device may respond at a time. A controller is used to command which device responds. (The HP 5384A or HP 5385A with HP-IB would make measurements and return data upon commands from a controller.)

1-25. The counter can be configured for either HP-IB or HP-IL, not both.

1-26. HP-IB or HP-IL allows the HP 5384A and HP 5385A to output data to other devices or, on a more complex level, respond to remote programming instructions to make a specific type of measurement, trigger that measurement, then read the result and send the reading back to the controller, or to another device on the interface.

1-27. OPTIONS

1-28. Option 001 is a Temperature Compensated Crystal Oscillator (TCXO) for HP 5384A. The TCXO is a 10 MHz oscillator, capable of making minor frequency corrections to compensate for temperature variations.

1-29. Option 003 is HP-IL, (Hewlett-Packard Interface Loop). HP-IL is a low cost, two-wire serial interface that permits communications from one device to another. As the name implies, the HP 5384A or HP 5385A is connected in a serial loop structure. Data or information, in the form of digital messages, travels from one device to the next in the loop. If the information is not intended for the counter, the counter merely passes the information on to the next device in the loop. If the information is intended for the counter, the counter responds as directed by the information.

1-30. Option 004 is an ovenized oscillator that gives the HP 5384A and HP 5385A increased accuracy by providing a more stable time base reference signal. The oven maintains the crystal at a constant elevated temperature for increased stability over the ambient temperature range.

1-31. Option 005 Battery Pack is a lead acid type battery that provides at least 3 hours of operation while the counter is disconnected from the power line. Operation time is reduced to approximately 1-hour when operated with HP-IB.

NOTE

If an instrument contains an Option 005 Battery Pack as well as the ovenized oscillator, the ovenized oscillator will draw power from the battery pack if no external ac or dc power is applied. Power will be drawn from the battery pack continuously with the instrument in either ON or STBY (standby) positions.

1-32. The battery pack will be recharged in 16 hours if the counter is in the standby mode and either the line cord is attached or external dc is applied through the rear panel jack. The battery will trickle charge while the counter is being used and is connected to either an ac power line or external dc.

1-33. INSTRUMENT IDENTIFICATION

1-34. Hewlett-Packard instruments have a 2-section, 10-character serial number (0000A00000), which is located on the rear panel. The four-digit serial prefix identifies the instrument changes. If the serial prefix of your instrument differs from that listed on the title page of this manual, there are differences between this manual and your instrument. Instruments having higher serial prefixes are covered with a "Manual Changes" sheet included with this manual. If the change sheet is missing, contact the nearest Hewlett-Packard Sales and Support Office listed at the back of this manual. Instruments having a lower serial prefix than that listed on the title page are covered in Section VII.

1-35. ACCESSORIES

1-36. The accessory supplied is a detachable power cord 229 cm long (7½ feet), part number 8120-1378.

1-37. Side Handle: 5061-1171

1-38. Rack Mount Kits:

Rack Mount Kit, HP Part Number 5060-0173.
Locking Rack Mount Kit for two HP 5384A/
HP 5385A modules, HP Part Number 5060-0174.

1-39. RECOMMENDED TEST EQUIPMENT

1-40. The test equipment listed in *Table 1-2* is recommended for use during performance tests, adjustments, and troubleshooting. Substitute test equipment may be used if it meets the required characteristics listed in the table.

Table 1-1. Models HP 5384A and HP 5385A Specifications

GENERAL

Check: 10 MHz Self-test
Gate Times: 0.1, 1, or 10 seconds, (NOMINAL).
Display: 12-digit alphanumeric liquid crystal.
Display Digits (variable): Frequency, 3 to 11;
 Period, 3 to 8.
Timebase Output: 10 MHz, 25 mV pk-pk (NOMINAL)
 into 50 ohm load.
External Timebase Input: 10 MHz, .5V rms into
 500 ohms; 15V (dc - ac pk) max.
Operating Temperature: 0° to 50°C
Power Requirements:
AC Operation: Selectable 18 VA max.
 115V + 10%, -25%, 48-66 Hz
 230V + 10%, -15% 48-66 Hz
 115V ±10%, 380-420 Hz
DC Operation: 9 - 15V dc, 1.0 A max.
Weight: Net, 2.2 kg (4.8 lbs.); Shipping, 4.1 kg (9 lbs.)
Dimensions: 216 mm W × 88 mm H × 276 mm D
 (8⁵/₈ × 3¹/₂ × 10⁹/₄ in.)

**INPUT CHARACTERISTICS
(Channel A HP 5384A/HP 5385A)**

Range: 10 Hz to 100 MHz
Sensitivity: (MAN LEVEL) off
 15 mV rms sine wave 50 Hz to 100 MHz
 25 mV rms sine wave 10 Hz to 50 Hz
 45 mV pk-pk 5 ns minimum pulse width
Dynamic Range: 45 mV to 4V pk-pk × attenuator
 setting.
Coupling: AC
Impedance:
 X1: 1 MΩ NOMINAL || < 25 pF
 X20: 500 kΩ NOMINAL || < 25 pF
Attenuator: X1 or X20 NOMINAL,
 X20 increases to X40 NOMINAL below 50 Hz.
Low Pass Filter: 100 kHz NOMINAL 3 dB point
Trigger Level:
(MAN LEVEL) ON: variable from -0.1V to +0.1V ×
 attenuator setting about average signal value.
(MAN LEVEL) OFF: automatically set to average
 value of signal.



Damage Level:
X1:
 10 - 200 Hz 350V (dc + ac peak)
 0.2 - 420 kHz 170V (dc + ac peak)
 0.42 - 10 MHz (5 × 10⁷V rms Hz)/FREQ
 >10 MHz 5V rms
X20:
 <1 MHz, Same as X1
 >1 MHz, 50V rms

(Channel B HP 5384A)

Range: 50 to 225 MHz
Sensitivity: 10 mV rms 50 to 200 MHz
 15 mV rms 200 to 225 MHz
Dynamic Range: 10 mV to 1V rms
Coupling: AC
Impedance: 50 ohm NOMINAL
Attenuator Level:
Manual: variable from X1 to X5
 (0 to 14 dB) NOMINAL.
Auto: AGC mode for improved noise
 suppression.
Damage Level: 350V dc + 5V rms ac

(Channel B HP 5385A)

Fuse protected. Front panel accessible.
Range: 90 to 1000 MHz
Sensitivity: 15 mV rms sine wave 90-100 MHz
 10 mV rms sine wave 100-1000 MHz
Dynamic Range: 10 mV to 7V rms (-27 to +30 dBm)
Coupling: AC
Impedance: 50 ohm NOMINAL
Attenuator Level:
Manual: variable from X1 to X18
 (0 to 25 dB) NOMINAL.
Auto: AGC mode for improved noise suppression.
Damage Level:
 AC >1 MHz +30 dBm (7V rms)
 AC <1 MHz 2V rms
 DC ±5V



TIMEBASE HP 5384A

Frequency: 10 MHz
Aging Rate: <3 × 10⁻⁷/mo.
Temperature: ±5 × 10⁻⁶, 0° to 50°C.ref. to 25°C.
Line Voltage: <1 × 10⁻⁷ for ±10% variation.



TIMEBASE HP 5385A (TCXO)

Frequency: 10 MHz
Aging Rate: <1 × 10⁻⁷/mo.
Temperature: ±1 × 10⁻⁶, 0° to 40°C. ref. to 25°C.
Line Voltage: <5 × 10⁻⁸ for ±10% variation.

FREQUENCY A and B

Range Channel A: 10 Hz - 100 MHz
Range Channel B:
 5384A: 50 MHz - 225 MHz
 5385A: 90 MHz - 1.0 GHz
LSD Displayed: 10 Hz to 1 nHz

$$\text{LSD} = \frac{4 \text{ ns}}{\text{Gate Time}} \times \text{FREQ}$$

Resolution: ±1 LSD

$$\pm \frac{(1.4 \times \text{Trigger Error} + 1 \text{ ns rms})}{\text{Gate Time}} \times \text{Freq}$$

Accuracy: ± Resolution ± Time Base
 Error × Frequency

Table 1-1. Models HP 5384A and HP 5385A Specifications (Continued)

PERIOD A

Range: 10 ns to 0.1 s

LSD Displayed: .001 fs to 10 ns

LSD: $\frac{4 \text{ ns}}{\text{Gate Time}} \times \text{period}$

Resolution: $\pm \text{LSD}$

$\pm \frac{(1.4 \times \text{Trigger Error} + 1 \text{ ns rms})}{\text{Gate Time}} \times \text{Per}$

Accuracy: $\pm \text{Resolution} \pm \text{Time Base Error} \times \text{Period}$

OPTIONS

Option 001 (HP 5384A), TXCO Timebase

Frequency: 10 MHz

Aging Rate: $<1 \times 10^{-7}/\text{mo.}$

Temperature: $\pm 1 \times 10^{-6}$, 0° to 40°C ref. to 25°C.

Line Voltage: $<5 \times 10^{-8}$ for $\pm 10\%$ variation.

Option 003, HP-IL

All HP-IL programmable functions, controls, and operations are the same as those for HP-IB except for interface functions Auto Address and Parallel Poll, which are also included.

R, AH, SH1, D, L1, (T1-5), C0, DC2, DT1, PP1, SR2, AA1, RL2, PD0, DD1.

Option 004, Oven Timebase

Frequency: 10 MHz

Aging Rate: $<3 \times 10^{-8}/\text{mo. (2)}$

Temperature: $\pm 1 \times 10^{-7}$, 0° to 50°C ref. to 25°C.

Line Voltage: $<2 \times 10^{-9}$ for a $\pm 10\%$ variation.

Battery Operation: The instrument operates for 3 hours (typical) with option 004.

Option 005, Battery

Type: Sealed Lead-acid; not covered under instrument warranty.

Capacity: Typically 4 hours of operation at 25°C (1).

Recharge Time: Typically 16 hours to 98% of full charge in instrument STBY (Standby) mode.

Battery Low Annunciator: Enabled 20 minutes prior to instrument shutdown nominally.

Line Failure Protection: Instrument automatically switches to battery in case of line failure.

Weight: Option 005 adds 1.4 kg. (3 lbs.) to weight of instrument. (1) without Option 004 installed. HP-IL replaces HP-IB when Option 005 is ordered from the factory.

HP-IB I/O Interface

Programmable Functions: Frequency A, Frequency B, Period A.

Programmable Controls: X20 Attn A, FILTER A, MAN LEVEL A/B, Gate Time.

Display: Normal, Increment, Decrement, Remote, Local

Miscellaneous Functions and Operating Commands: Diagnostics, 10 MHz Check, reset, initialize, Wait To Send ON/OFF Device ID.

Interface Functions: Device Clear, Group Execute Trigger Interface Clear, Local, Local Lockout, Send Status, Remote, Service Request.

SH1, AH1, T5, TE0, L4, LE0, SR1, RL1, PP0, DC1, DT1, C0, E1.

Data Output:

Output will be maximum resolution for the gate time selected and is not affected by the front panel Display Digits keys.

Format: 17 characters plus CR and LF (blanks may be inserted).

Rate: 4 readings/s maximum at .1 s gate.

Talk only: Set with address switch=31.

DEFINITIONS

Measurement Gate Time: Selected value $\pm 15\%$ + up -to 1 period of input.

Dynamic Range: Minimum to maximum input voltage swing allowed for correct frequency counting.

LSD Displayed: Dependent on gate time, input signal, and DISPLAY DIGITS control. In NORM mode, 8 digits are displayed. Using the display control, up to 11 digits may be present for frequency measurements, 8 digits maximum for period.

LSD: Unit value of least significant digit rounded to the nearest decade, i.e., 4 Hz → 1 Hz, 6 Hz → 10 Hz.

Trigger Error:

Channel A:

$\frac{\sqrt{(ei)^2 + (en)^2}}{\text{Input slew rate at trigger point}}$ s rms,

where ei and en are input noise voltages (rms) for the counter and signal, respectively, for a 100 MHz bandwidth.

$ei \leq 100 \mu\text{V rms}$,

Channel B: negligible due to high signal slew rate at the trigger point.

Best Case Resolution for 1 second gate (\pm Hz)

Amplitude	Frequency (Hz)									
	10	100	1K	10K	100K	1M	10M	100M	200M	1.0G
mV rms										
50	.0003	.0003	.0003	.0003	.0008	.004	.04	0.4	0.8	4.0
100	.0002	.0002	.0002	.0003	.0007	.004	.04	0.4	0.8	4.0
500	.0002	.0002	.0002	.0003	.0006	.004	.04	0.4	0.8	4.0
1000	.0001	.0001	.0001	.0001	.0005	.004	.04	0.4	0.8	4.0

This chart shows best case frequency resolution vs sine wave input voltage (rms). Noise from the signal source is assumed to be zero and trigger error produced only by the counter's noise (i.e., 100 $\mu\text{V rms}$).

LSD DISPLAYED: Unit value of least significant digit rounded to the nearest decade, i.e., 4 Hz → 1 Hz, 6 Hz → 10 Hz.

Table 1-2. Recommended Test Equipment

Instrument	Critical specifications	Recommended Model	Use
50 Ohm Feedthrough	BNC Type	HP 10100C	P,A,T
Tee Connector	BNC Type	HP 1250-0781	P,A,T
Cables	BNC 50 ohm	HP 11170C	P,A,T
Oscilloscope	100 MHz Bandwidth	HP 1740A	A,T
Synthesized Generator	90-1000 MHz	HP 8660C/86602A	P,T
Signal Generator	50-225 MHz	HP 8656A	P,A,T,
Signal Generator	90-1000 MHz	HP 804A	P,T
Synthesized Function Generator	10 Hz to 20 MHz	HP 3325A	P,A,T
DC Voltmeter	20V Range, 0.05V resolution	HP 3465	A,T
Power Splitter	90 MHz-1 GHz Cal. output	HP 11667A	A,T
Power Meter/Sensor	90 MHz-1 GHz, -9 to -24 dBm	HP 436A/8481A	P
10 dB Attenuator		HP 8491A	P
Adapter, Coaxial (2 required)	Type N(male)-to-BNC(female)	1250-07680	P
Adapter, Coaxial	Type N(male)-to-BNC(male)	1250-0082	P
Controller	HP-IB Compatible	HP-85F*	
Controller	HP-IL Compatible	HP-41CV	P
Interface	HP-IL Compatible	HP 82938A	
Resistor	10Ω 20W	0811-1655	A

*HP-85F consists of the following:

Controller HP-85A
 I/O ROM 00085-15003
 ROM Drawer HP 82936A
 HP-IB Interface Card/Cable HP 82937A

SECTION II INSTALLATION

2-1. INTRODUCTION

2-2. This section contains information for unpacking, inspection, storage, and installation.

2-3. UNPACKING AND INSPECTION

2-4. If the shipping carton is damaged, inspect the instrument for visible damage (scratches, dents, etc.). If the instrument is damaged, notify the carrier and the nearest Hewlett-Packard Sales and Service Office immediately (offices are listed at the back of this manual). Keep the shipping and packing material for the carrier's inspection. The Hewlett-Packard Sales and Service Office will arrange for repair or replacement of your instrument without waiting for the claim against the carrier to be settled.

2-5. PREPARATION FOR USE

CAUTION

Before connecting the instrument to ac power lines, be sure that the voltage selector is properly positioned as described below.

2-6. POWER REQUIREMENTS

2-7. The counter has the following ac power requirements:

- 115V, +10%, -25%, 48-66 Hz single phase
- 230V, +10%, -15%, 48-66 Hz single phase
- 115V, +10%, -10%, 380-420 Hz single phase

2-8. LINE VOLTAGE SELECTION

2-9. The power line voltage is selected by the position of the LINE SELECT switch on the rear panel. Sliding the switch to the left selects 115V operation, sliding the switch to the right selects 230V operation. The voltages available are printed on the switch. The specific voltage selected will be visible on the LINE SELECT switch, as shown in Figure 2-1. Before applying power, verify that the LINE SELECT switch is properly set for the desired ac supply voltage and that the correct fuse is installed.

2-10. AC Line Fuse Selection

2-11. The ac line fuse is not accessible from the outside of the cabinet. The cabinet should be opened

only by qualified service personnel. The correct fuse value is 250 mA/250V Slow Blow for 115V or 230V operation.

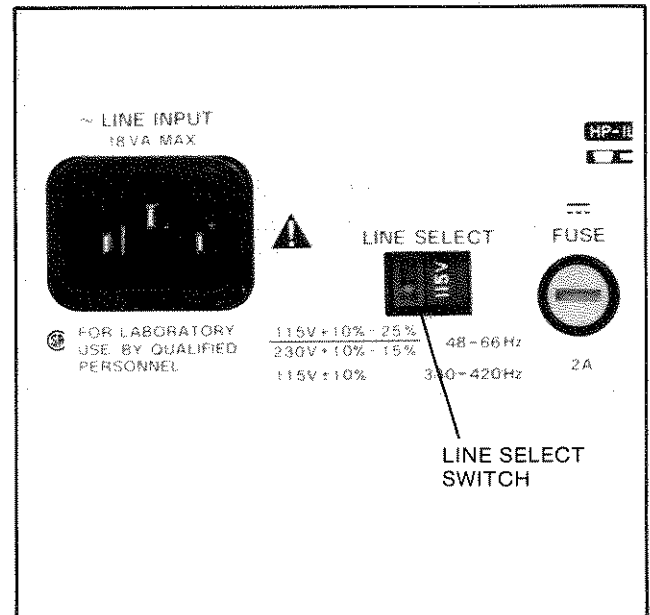

Figure 2-1. Line Voltage Selection

2-12. DC Fuse Selection

2-13. To replace the dc fuse use a small flat-bladed screwdriver to remove the fuse from the fuseholder. Press in slightly and turn counterclockwise, until the fuse carrier springs free. Replace the fuse in the fuse carrier and reinstall by inserting and turning clockwise. Be sure to install the correct fuse value; 2 A/250V fast blow.

2-14. The dc fuse is the main protective device for the instrument. The dc fuse will blow whether the dc current source is the optional battery pack, power from the external dc power jack, or the built-in ac power supply.

2-15. Power Cable

2-16. The counter is shipped with a three-wire power cable. When the cable is connected to an appropriate ac power source, this cable connects the instrument chassis to earth ground. The type of power cable plug shipped with each instrument depends on the country

of destination. Refer to *Figure 2-2* for the part numbers of the power cable and plug configurations available.

WARNING

BEFORE ENERGIZING THIS INSTRUMENT, THE PROTECTIVE EARTH TERMINAL OF THIS INSTRUMENT MUST BE CONNECTED TO THE PROTECTIVE CONDUCTOR OF THE (MAINS) POWER CORD. THE MAINS PLUG SHALL ONLY BE INSERTED IN A SOCKET OUTLET PROVIDED WITH A PROTECTIVE EARTH CONTACT. THE PROTECTIVE ACTION MUST NOT BE NEGATED BY THE USE OF AN EXTENSION CORD (POWER CABLE) WITHOUT A PROTECTIVE EARTH (GROUNDING) CON-DUCTOR.

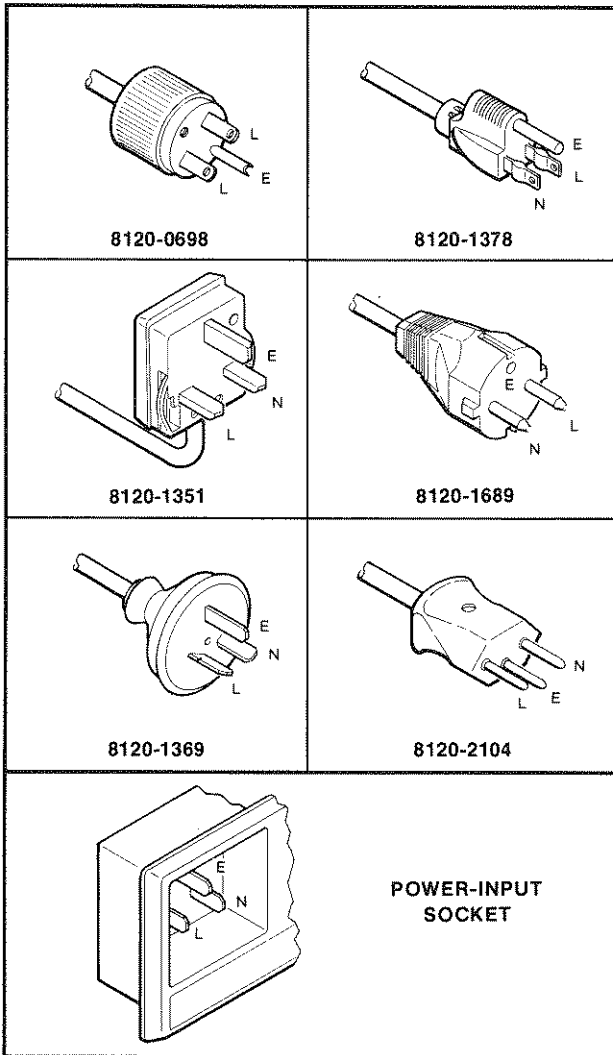

Figure 2-2. Power Cable HP Part Number versus Mains Plugs Available

2-17. HP-IB Interconnections

2-18. HEWLETT-PACKARD INTERFACE BUS. The counter with HP-IB is compatible with the Hewlett-Packard Interface Bus. Interconnection data concerning the rear panel HP-IB connector is provided in *Figure 2-3*. This connector is compatible with the HP 10833A/B/C/D cables. (See *Table 2-1* for cable descriptions). The HP-IB system allows interconnection of up to 15 (including the controller) HP-IB compatible instruments.

Table 2-1. HP-IB Cable Descriptions

HP Model	Cable Length
10833A	1 metre (3.3 feet)
10833B	2 metres (6.6 feet)
10833C	4 metres (13.2 feet)
10833D	0.5 metres (1.6 feet)

2-19. The HP-IB cables have identical "piggy-back" connectors on both ends so that several cables can be connected to a single source without special adapters or switch boxes. System components and devices may be connected in virtually any configuration desired. There must, of course, be a path from the calculator (or other controller) to every device operating on the bus. As a practical matter, avoid stacking more than three or four cables on any one connector. If the stack gets too large, the force on the stack produces great leverage which can damage the connector mounting. Be sure each connector is firmly (finger tight) screwed in place to keep it from working loose during use.

2-20. CABLE LENGTH RESTRICTIONS. To achieve design performance with the HP-IB, the proper voltage levels and timing relationships must be maintained. If the system cable is too long, the lines cannot be driven properly, and the system will fail to perform properly. Therefore, when interconnecting an HP-IB system, it is important to observe the following rules.

- a. The total cable length for the system must be less than or equal to 20 metres (65.6 feet).
- b. The total cable length for the system must be less than or equal to 2 metres (6.6 feet) times the total number of devices connected to the bus.
- c. The total number of instruments connected to the bus must not exceed 15.

2-21. HP-IB Talk/Listen Address Switch

2-22. The HP 5384A and HP 5385A provide a rear panel HP-IB instrument address selection switch. This switch determines the mode of remote operation as

PIN	LINE
1	DIO1
2	DIO2
3	DIO3
4	DIO4
13	DIO5
14	DIO6
15	DIO7
16	DIO8
5	EOI
17	REN
6	DAV
7	NRFD
8	NDAC
9	IFC
10	SRQ
11	ATN
12	SHIELD-CHASSIS GROUND
18	P/O TWISTED PAIR WITH PIN 6
19	P/O TWISTED PAIR WITH PIN 7
20	P/O TWISTED PAIR WITH PIN 8
21	P/O TWISTED PAIR WITH PIN 9
22	P/O TWISTED PAIR WITH PIN 10
23	P/O TWISTED PAIR WITH PIN 11
24	ISOLATED DIGITAL GROUND

THESE PINS
ARE
INTERNALLY
GROUNDED

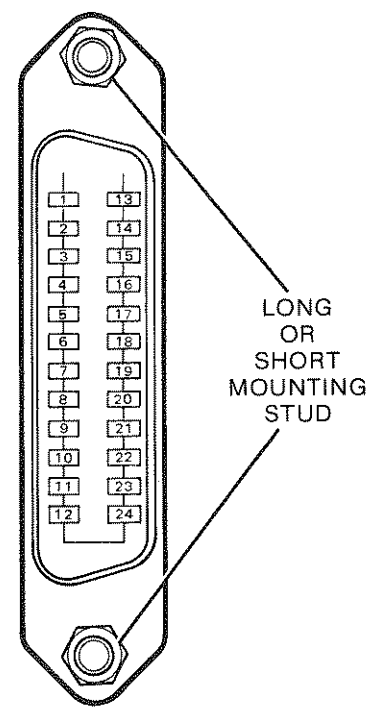

CAUTION

The HP 5384A/HP 5385A contains metric threaded HP-IB cable mounting studs as opposed to English threads. Metric threaded HP 10833A, B, C, or D HP-IB cable lock screws must be used to secure the cable to the instrument. Identification of the two types of mounting studs and lock screws is made by their color. English threaded fasteners are colored silver and metric threaded fasteners are colored black. DO NOT mate silver and black fasteners to each other or the threads of either or both will be destroyed. Metric threaded HP-IB cable lock screw illustration and part number follows.

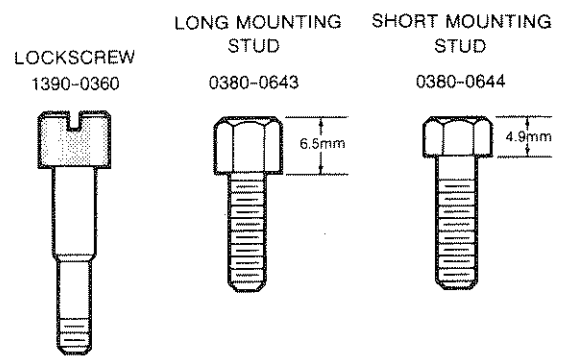

Logic Levels

The Hewlett-Packard Interface Bus logic levels are TTL compatible, i.e., the true (1) state is 0.0V dc to 0.4V dc and the false (0) state is +2.5V dc to +5.0V dc.

Programming and Output Data Format

Refer to Section III, Operation

Mating Connector

HP 1251-0293; Amphenol 57-30240.

Mating Cables Available

HP 10833A, 1 metre (3.3 ft.), HP 10833B, 2 metres (6.6 ft.),
HP 10833C, 4 metres (13.2 ft.), HP 10833D, 1/2 metre (1.6 ft.).

Cabling Restrictions

1. A Hewlett-Packard Interface Bus System may contain no more than 2 metres (6.6 ft.) of connecting cable per instrument.
2. The maximum accumulative length of connecting cable for any Hewlett-Packard Interface Bus System is 20.0 metres (65.6 ft.).
3. The maximum number of instruments in one system is fifteen.

Figure 2-3. Hewlett-Packard Interface Bus Connections



HP 5384A and HP 5385A Installation

“Talk Only” or “addressable”, and selects the HP-IB address. Instructions for changing the address are provided in Section III of this manual.

2-23. HP-IB Description

2-24. A description of the HP-IB is provided in Section III of this manual. A study of this information is necessary if the user is not familiar with the HP-IB concept. Additional information concerning the design criteria and operation of the bus is available in IEEE Standard 488-1978, titled “IEEE Standard Digital Interface for Programmable Instrumentation”.



The above symbol when located in the upper corner of a page indicates HP-IB information is contained on that page. This information may be operation, performance, adjustments, or service related.

2-25. HP-IL Interconnections (Option 003)

2-26. The HP 5384A and HP 5385A with Option 003 are compatible with the Hewlett-Packard Interface Loop. The interface loop connection is made by a pair of two-wire balanced line cables. The cable is limited to 10 metres (32.8 feet) for unshielded cables (from one device to the next) and to 100 metres (328 feet) for shielded cables. A typical interface connection is shown in Figure 2-4.

Table 2-2. HP-IL Cable Descriptions

HP Model	Length
82167A	.5 metres (1.64 feet)
82167B	1 metre (3.28 feet)
82167D	10 metres (32.8 feet)

2-27. HP-IL Description

2-28. An introductory description on HP-IL is provided in Section III of this manual. As HP-IL is a relatively new concept, it is recommended that users unfamiliar with the Interface Loop concept review this material prior to operating the instrument remotely.



The above symbol when located in the upper corner of a page indicates HP-IL information is contained on that page. This information may be operation, performance, adjustment, or service related.

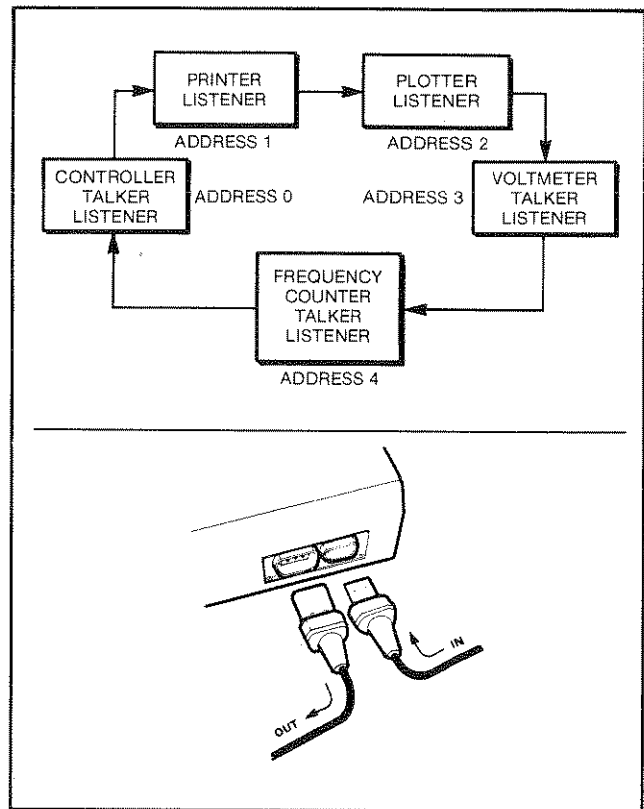

Figure 2-4. Typical HP-IL Interface Connection

2-29. Channel B Input Fuse

2-30. Figure 2-5 shows the details of how to change the fuse in the channel B input of the HP 5385A.

2-31. Operating Environment

2-32. TEMPERATURE. The counter may be operated in temperatures from 0°C to +50°C.

2-33. HUMIDITY. The counter may typically be operated in environments with humidity up to 95% at 40°C. However, it should be protected from extreme temperatures which may cause condensation in the instrument.

2-34. ALTITUDE. The counter may be typically operated at altitudes up to 4,600 metres (15,000 feet).

2-35. STORAGE AND SHIPMENT

2-36. Environment

2-37. The instrument may be stored or shipped in environments within the following limits:

- TEMPERATURE -40°C to +75°C
- HUMIDITY ... Up to 95% noncondensing
- ALTITUDE 15,240 Metres (50,000 feet)

2-38. The instrument should also be protected from temperature and humidity extremes which cause condensation within the instrument.

2-39. Packaging

2-40. ORIGINAL PACKAGING. Containers and materials identical to those used in the factory packaging are available through Hewlett-Packard offices. If the instrument is being returned to Hewlett-Packard for servicing, attach a tag indicating the type of service required, return address, model number, and full serial number. Also, mark the container FRAGILE to ensure careful handling. In any correspondence, refer to the instrument by model number and full serial number.

2-41. OTHER PACKAGING. The following general instructions should be used for repacking with commercially available materials.

a. Wrap the instrument in heavy paper or plastic. If you are shipping to a Hewlett-Packard office or

service center, attach a tag indicating the type of service required, return address, model number, and full serial number.

b. Use a strong shipping container. A double-wall carton made of 350-pound test material is adequate.

c. Use a layer of shock-absorbing material 70 to 100 mm (3- to 4-inch) thick around all sides of the instrument to provide firm cushioning and prevent movement inside the container. Protect the control panel with cardboard.

d. Seal the shipping container securely.

e. Mark the shipping container FRAGILE to ensure careful handling.

f. In any correspondence, refer to the instrument by model number and full serial number.

2-42. WHERE TO SHIP YOUR UNIT FOR REPAIR

2-43. Return your unit to the nearest designated Hewlett-Packard Sales and Support Office. Check the back of this manual for the address.

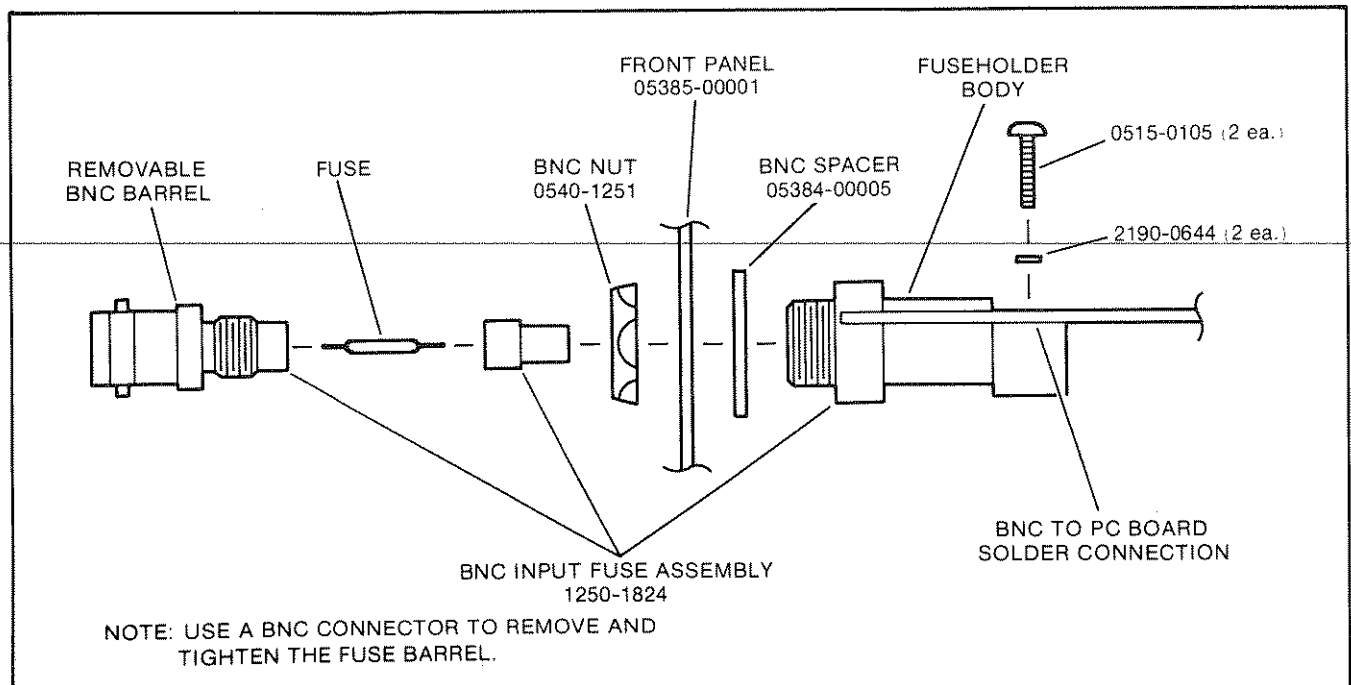

Figure 2-5. Details of Input Connector J2 and Fuse Mounting

2-44. FIELD INSTALLATION OF OPTIONS

2-45. The following information provides instructions for installation of the various options for the HP 5384A and HP 5385A.

2-46. Refer to *Table 2-3* for a list of the parts required for installation of each option.

Table 2-3. Required Parts for Field Installed Options

Opt.	Ref. Des.	Description	Pt. No.
001	Y1B R101 C67	10.0 MHz TCXO 422 ohm, 1%, .125W .01 μ F, \pm 20%, 100 Vdc	0960-0612 0698-3447 0160-3879
003	A4	HP-IL Assembly	05006-60004
004	T1A R95 L5	10 MHz Oven Oscillator Module 100 ohm, 1%, .125W Inductor, Wide-band, $Z_{max} = 680$ ohm @ 180 MHz	0960-0636 0757-0401 9100-1788
005		Battery Pack Assembly Heat Sink Compound	05384-60103 8500-0269

WARNING

TO PREVENT ELECTRICAL SHOCK, REMOVE ALL POWER FROM THE COUNTER BEFORE REMOVING THE TOP COVER.

2-47. To obtain the necessary parts for installation of an option, order by part number as listed in *Table 2-3*. Refer to Section VI for further ordering information.

2-48. Option 001 (TCXO) Installation

2-49. The Option 001 TCXO replaces the standard reference oscillator in the HP 5384A. The standard oscillator is located on the A1 motherboard underneath the interface board. The standard oscillator components must first be removed before the TCXO can be installed. Proceed as follows.

- a. Remove the ac power cord.
- b. Remove the vinyl strips on each side of the counter by peeling them off.
- c. Remove the four pozidriv screws located at the bottom of the counter. The rear feet must be removed to access the two rear screws. Removal instructions are molded into each foot.
- d. Lift off the top cover from the counter.
- e. Remove the metal rack mount brackets.

- f. Remove the four black spacer tubes.
- g. Remove the two pozidriv screws securing the A1 motherboard to the bottom cover.
- h. Remove the bottom cover.
- i. Remove the interface board.
- j. Remove the standard oscillator by removing the following components:

C61-C66, R96-R99, R110, Q13, Q14, Y1C.

- k. Install the TCXO by soldering the following components in place:

C67, R101, Option 001 TCXO (Y1B).

- l. Install the interface board.
- m. Install top and bottom covers by following steps "a" through "h" in reverse order.
- n. Refer to Section V for the TCXO adjustment procedure.

2-50. Option 003 HP-IL Installation

2-51. The Option 003 HP-IL replaces HP-IB. To install the Option 003, proceed as follows:

- a. Remove the ac power cord.
- b. Remove the vinyl strips on each side of the counter by peeling them off.
- c. Remove the four pozidriv screws located at the bottom of the counter. The rear feet must be removed to access the two rear screws. Removal instructions are molded into each foot.
- d. Lift off the top cover from the counter.
- e. Remove the metal rack mount brackets.
- f. Remove the four black spacer tubes.
- g. Remove the two pozidriv screws securing the A1 motherboard to the bottom cover.
- h. Remove the bottom cover.
- i. Remove the HP-IB board.
- j. Insert the 28 pin IC (U1) in its socket on the HP-IL board.
- k. Insert the 40 pin IC (U2-1) in its socket on the HP-IL board.
- l. Insert the 24 pin IC (U2-2) in its socket on top of U2-1.
- m. Place the board on the plastic standoff support and secure the bracket to the rear panel of the counter with the two screws provided.

- n. Insert the flat ribbon cable connector into J8 on the motherboard.
- o. Install top and bottom covers by following steps “a” through “h” in reverse order.

2-52. Option 004 Oven Oscillator Installation

2-53. The Option 004 Oven Oscillator replaces the standard reference oscillator in the 5384A or the TCXO in the 5385A. To install the Option 004 proceed as follows:

- a. Remove the ac power cord.
- b. Remove the vinyl strips on each side of the counter by peeling them off.
- c. Remove the four posidriv screws located at the bottom of the counter. The rear feet must be removed to access the two rear screws. Removal instructions are molded into each foot.
- d. Lift off the top cover from the counter.
- e. Remove the metal rack mount brackets.
- f. Remove the four black spacer tubes.
- g. Remove the two pozidriv screws securing the A1 motherboard to the bottom cover.
- h. Remove the bottom cover.
- i. Remove the interface board.
- j. If the counter is an HP 5384A with a standard oscillator, remove the standard oscillator by removing the following components:

C61-C66, R96-R99, R110, Q13, Q14,
Y1C, jumper W2.

- k. If the counter is an HP 5384A or HP 5385A with a TCXO, remove Y1B, R95, and jumper W2.
- l. Install Y1A, the 100 ohm resistor in the R95 position and the inductor in the L5 position.
- m. Reassemble the counter by following steps “a” through “i” in reverse order.
- n. Refer to Section V for the oscillator adjustment procedure.

2-54. Option 005 Battery Pack Installation

2-55. The following instructions describe how to attach the battery pack assembly to the inside of the counter's top cover. The battery pack is attached far enough forward to clear the power transformer and interface board when the cover is replaced. To install the battery pack:

- a. Remove the top cover and place it upside-down on a sturdy level surface, with the front of the cover toward you.
- b. Place a plastic washer on each of the five unpainted studs ($\frac{5}{16}$ " high \times $\frac{3}{8}$ " dia.) on the inside of the top cover. (A sixth stud at the rear of the cover is painted flat black and remains unused.)
- c. Lay the battery frame on top of the five plastic washers. The battery frame is the aluminum sheet-metal plate that has five holes and a “+” and “-” symbol punched into it.

NOTE

There are also two tabs formed in it to position the battery. Insure the battery frame is mounted with the “+” and “-” symbol toward the front of the cover.

- d. Secure the battery frame to the top cover by installing push-on retainer rings onto the five studs. Use as pushing tool any nonscratching rigid tubing that will fit over the studs.
- e. Set the battery on the battery frame between the two upright tabs so the “+” and “-” battery terminals match the “+” and “-” symbols punched into the battery frame.
- f. Secure the battery by first aligning the “+” and “-” terminals on the battery with the “+ POS” and “- NEG” labels on the battery stop; then place the battery stop over the battery. Secure the battery stop with four screws and four lock washers.

NOTE

The battery stop can be identified by locating a $3\frac{1}{2} \times 5\frac{1}{2}$ inch aluminum sheetmetal box-like form that partially encloses the battery. There are several cautions printed on it. The battery stop also provides a mounting surface for the battery charger board.

- g. Thread the red lead from the bottom of the A3 board through the larger of two holes in the corner near A3F1 (the “+” location). Insert the lead in the smaller hole (in the trace) and pull the excess wire back through the hole. Solder the lead then clip off excess lead length.
- h. Install the black lead at the “-” location near A3J1 in the same manner as the red lead (step “g”).
- i. Mount the battery charger board by inserting two tabs on the PC board into the two slots in the battery stop. The slots are located in the rear facing side of the battery stop. Temporarily secure the board with one screw.

- j. Place the transistor in the Q2 location so the hole in the transistor heat sink aligns with the threaded hole in the battery stop. Trim the leads on the transistor to provide clearance between the A3 board and the battery stop.
- k. Secure the heat sink temporarily to the battery stop with a screw.
- l. Solder one lead of the transistor to the A3 board.
- m. Remove the A3 board and solder the remaining two leads. Clip the soldered leads to avoid shorting against the battery stop.
- n. Spread heat sink compound on the back of the transistor. Enough compound should be applied so that when the transistor is secured to the battery stop (step "p") a tiny amount will ooze from underneath the transistor. Good thermal conduction will result.
- o. Place the transistor insulator underneath transistor Q2: The tab fits into a slot at the edge of the A3 board. Align The hole in the insulator with the hole in the heat sink.
- p. Place the insulator washer on the heat sink, secure Q2 to the battery stop with a screw.
- q. Secure the A3 board to the battery stop with two screws and two lock washers.
- r. Attach the rubber bumper to the battery stop in the square silk screened on the battery stop.
- s. Connect the ribbon cable W2 to A3J1 and A1J9.
- t. Test and adjust the battery charger board. Refer to Section V, paragraph 5-26, for adjustment procedures.
- u. Replace the cover on the counter, installation is complete.

SECTION III OPERATION AND PROGRAMMING

3-1. INTRODUCTION

3-2. This section gives complete operation and programming information for the HP 5384A and HP 5385A Frequency Counters. Descriptions of all front panel controls, connectors, and indicators, as well as an operator's check, operating instructions, programming instructions and codes, and operator's maintenance, are provided. Unless otherwise specified, all information pertains to both counters.

3-3. OPERATING CHARACTERISTICS

3-4. The HP 5384A and HP 5385A can be configured for system or benchtop use. They make frequency and period measurements. Inputs enter through two channels. Raw data from the input measurements are used by the counter's microcomputer to compute and format the result either for display or transmission over the interface. The operating range, resolution and accuracy for each individual functional mode is given in the Specifications, *Table 1-1*.

3-5. Descriptions of and operating instructions for Options 001, 003, 004, 005 are provided in this section.

3-6. OPERATING INSTRUCTIONS

3-7. Information and instructions for operating the HP 5384A and HP 5385A in both local and remote modes are provided in this section. The following paragraphs summarize the organization and content of the operating information.

3-8. LOCAL OPERATION. The operating information for local (or manual) operation of the counter consists of the following topics:

General Operation Information. The General Operation Information describes the basic operation of the instrument display, the inputs, and the front panel keyboard.

Front and Rear Panel Features. The front and rear panel features consists of *Figures 3-7* through *3-9* which locate and describe all the operator controls and indicators.

Making Frequency and Period Measurements. Making Frequency and Period Measurements describes the recommended procedure for making a measurement.

3-9. REMOTE OPERATION. A good working knowledge of the local operation of the counter is essential for remote programming, as most of the data messages perform the same key-stroke-like sequences. The Remote Operation/Programming instructions describe the following:

- Interface Description
- Interface Functional Overview
- Interface System Overview
- Address Selection
- Interface Function
- Interface Commands
- Input Format
- Output Format
- Measurement Triggering in Remote SRQ, SRQ Mask, and Status Byte
- Device Dependent Commands
- Device Command Definitions
- Power-up and Default States
- Programming Examples

3-10. OPERATOR'S MAINTENANCE

3-11. The only maintenance the operator should normally perform is the replacement of the dc fuse. Refer to Section II, Line Voltage Selection, for instructions on changing the fuse.

3-12. The standard oscillator adjustment is also accessible from the rear panel. The oscillator is factory set at 10 MHz. Once adjusted, the oscillator should need little future attention except for periodic calibration using a precision frequency source. To adjust the standard oscillator, refer to Section V, Standard Oscillator Adjustment.

3-13. GENERAL OPERATION INFORMATION

3-14. Introduction

3-15. The following paragraphs describe the general operating features of the HP 5384A and HP 5385A Frequency Counters.

3-16. Display

3-17. All display functions are performed by a Liquid Crystal Display assembly. The assembly contains 12 alphanumeric characters; the display format for all measurements is in engineering notation. The left-

most character is CHARACTER 1 and the rightmost is CHARACTER 12. The scale or units designation will normally be shown in character positions 10, 11, and 12. If positions 10 and 11 are required to display a high resolution measurement, only character position 12 will be used to designate the scale or units.

3-18. Annunciation for all operating modes is also indicated by the display. When a mode is selected, an arrow appears at the bottom of the display just above the name of the mode label on the front panel.

3-19. Keyboard

3-20. The keyboard, located on the front panel, is a 14-position pushbutton assembly which is connected to a port on the microcomputer. The keyboard is divided into several groups, according to the purpose of the keys. From the left after the power switch, we have A, B, A&B, GATE, and DISPLAY DIGITS keys.

3-21. A blue RESET/LOCAL key and the CHECK key complete the keyboard assembly of the counter.

3-22. INPUTS

3-23. Immediately to the right of the keyboard is the INPUTS section. There are two BNC inputs (Channels A and B) and a control for either adjusting the trigger level of Channel A or attenuating the input signal to Channel B.

3-24. Power-Up/Self-Check

WARNING

BEFORE USING THE INSTRUMENT, ALL PROTECTIVE EARTH TERMINALS, EXTENSION CORDS, AUTOTRANSFORMERS AND DEVICES CONNECTED TO IT SHOULD BE CONNECTED TO A PROTECTIVE EARTH GROUNDED SOCKET. ANY INTERRUPTION OF THE PROTECTIVE EARTH GROUND WILL CAUSE A POTENTIAL SHOCK HAZARD THAT COULD RESULT IN PERSONAL INJURY.

CAUTION

Before energizing the counter, the instrument must be set to the voltage of the power source or damage to the instrument may result. See Section II.

3-25. When you power-up the counter, an internal check is automatically made of several major com-

ponents in its circuitry. During this cycle, all 12 Liquid Crystal Display (LCD) digits will be momentarily activated in a starburst pattern. Also activated are the colons and annunciators. The address of the interface will briefly be displayed.

3-26. After the power-up sequence, the counter initializes itself. That is, Frequency A mode is selected for display and the preset trigger level mode is selected. The ATTN and LPF modes are disabled, and the gate time is set to 0.1 s. If no input signal is present after the Power-Up cycle, 00000000 will appear on the display. The power-up initialize state is listed in Table 3-1.

Table 3-1. Power-Up Initialize States

FUNCTION	STATE
REMOTE/LOCAL	LOCAL
GATE TIME	0.1 s
MANUAL LEVEL	OFF
WAIT-TO-SEND	OFF
DISPLAY DIGITS	NORMAL
FUNCTION	FREQ A
X20 ATTN	X1
FILTER	OFF
REMOTE DISPLAY	OFF

3-27. Any failure during the power-up cycle will cause an error message to be displayed momentarily. After the error is displayed, the counter will attempt to operate normally.

3-28. Error Messages

3-29. The counter will display error messages whenever the instrument enters an error state. Errors can occur either during self-test or after an improper operation has been attempted through the interface.

3-30. If an error occurs during power-up self-test, error messages will appear on the display. The message will be displayed for approximately one second to give the operator sufficient time to read the message. One second after the error is displayed, the counter will attempt to operate normally.

3-31. If an error occurs during the power-up self-test, the ERROR annunciator will be turned on. This annunciator will stay on as long as the instrument does not enter the diagnostic mode to warn the operator of potentially inaccurate results.

3-32. Several types of errors can occur when an improper operation is attempted through the interface. Whenever an error message is generated because of an illegal operation, the error message will

be displayed until the RESET/LOCAL key is pressed or a DCL (device clear) command is sent to the counter by the controller. Illegal commands can either be commands not recognizable to the counter or commands which are recognizable, but are invalid if the counter is in the diagnostic or talk only modes.

3-33. Instrument error messages are listed in *Table 3-2*.

Table 3-2. Error Messages

Error	Messages
10	Self-test error
50	Unrecognizable mnemonic in command
51	Illegal numeric in command
52	First character of command is illegal
53	Illegal character in the "DR" (remote display) command
55	Invalid HP 5384A/85A command or HP-IL protocol or frame error
56	Invalid diagnostic command
60	ROM failure in I/O processor
61	RAM failure in I/O processor
70	Controller connected to talk-only instrument

3-34. If the fuse in the Channel B input opens, the message "INPUT ERROR" will appear on the display.

3-35. FRONT PANEL FEATURES

3-36. The front panel controls, indicators, and connectors are shown in *Figures 3-7* through *3-9*.

3-37. The following paragraphs describe the general purpose and use of the operator keys and controls. They are discussed by functional grouping, as follows:

- a. ON/STBY
- b. A CHANNEL
- c. B CHANNEL and A&B
- d. GATE and DISPLAY DIGITS
- e. RESET/LOCAL and CHECK
- f. INPUTS

3-38. ON/STBY

3-39. The ON/STBY switch connects or disconnects the output from the +5-volt supply to the rest of the instrument. It does not control the ac power line at the primary of the power transformer. If Option 004, the ovenized oscillator is installed, +5 volts is supplied

to the oscillator whether the power switch is in the STBY (standby) mode or in the ON mode (with the ac power cord or external dc connected). *Figure 3-1* shows the ON/STBY switch.

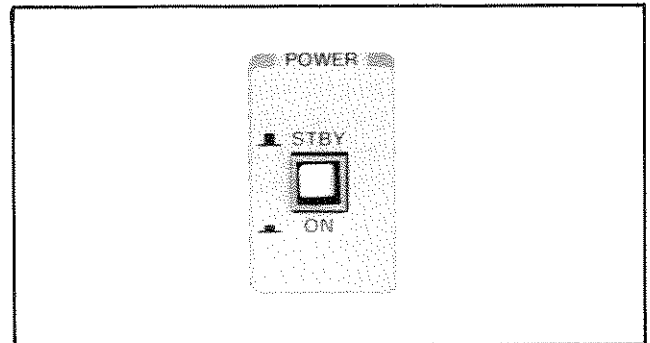

Figure 3-1. Front Panel ON/STBY Switch

3-40. A CHANNEL

3-41. Function selection for the HP 5384A and HP 5385A is accomplished through a simple one key per function keyboard. You may select from four function modes (labeled in black) accessible from the four keys grouped under A. The arrows appearing in the bottom of the display identifies which functions are active. The four functions in the A channel group are: **FREQ**, **X20 ATTN**, **PER**, **FILTER**. Refer to *Figure 3-2*, Front Panel A Channel Function Keys.

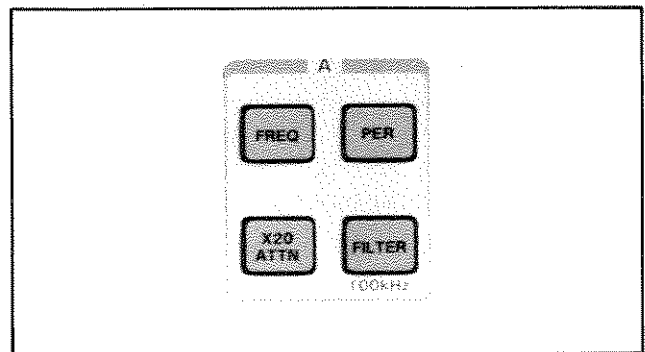

Figure 3-2. Front Panel A Channel Function Keys

3-42. **FREQ** key selects the frequency mode of operation for the A channel input. The frequency range of Channel A in both counters is 10 Hz to 100 MHz. When Channel A is selected, a black arrow appears in the bottom of the LCD over the "A" label located directly below the display window and the frequency at input A is measured and displayed.

3-43. If the counter has just been powered-up, Channel A is automatically selected (initialize mode) with a gate time of 0.1 s. If the counter has been

operated since being powered-up, the frequency measurement is made using the last gate time selected.

3-44. PER key selects the period mode of operation for the Channel A input. When the PER key is pressed, the period of the signal at input A is measured. The measurement is automatically made using the last gate time selected. The gate time is displayed in the right side of the LCD. As in frequency A, the resolution of the measurement is affected by the gate time, since the HP 5384A/85A are reciprocal counters.

3-45. Reciprocal counters use the gate time to accumulate events (cycles of input signal) during the length of the gate time. The gate time is divided by the number of events (by the microcomputer) to determine the average period of the signal. The longer the gate time, the larger number of events are accumulated. An increased number of accumulated events will increase the resolution of the measurement.

3-46. X20 ATTN key provides attenuation of the input signal on Channel A by a factor of approximately 20. Each press of the X20 ATTN key toggles between enabling and disabling an attenuation circuit. When a black arrow appears in the LCD above the "ATTN" label, the signal is attenuated. When no arrow appears, the signal is not attenuated.

3-47. The X20 ATTN sets the sensitivity of the Channel A input to either 10 mV rms or 200 mV rms range if the MANUAL TRIG LEVEL A control (discussed later) is in midrange position or disabled. The X20 ATTN operates independently of the front panel key MAN LEVEL. When the MAN LEVEL key is enabled, the X20 ATTN function will cause the range of the MANUAL TRIG LEVEL A control to increase approximately 20 times.

3-48. The FILTER key provides a 100 kHz Low Pass Filter that can be toggled into or out of the Channel A signal path. The Low Pass Filter will attenuate frequencies above 100 kHz. When the FILTER is in the signal path, a black arrow will appear in the LCD above the label "FILT".

3-49. The FILTER will improve the accuracy and resolution of frequency measurements below 100 kHz by blocking high frequency signals and noise that may be riding on the low frequency being measured.

3-50. B Channel and A&B

3-51. *Figure 3-3* shows the front panel B and A&B function keys. The **FREQ** key selects the frequency

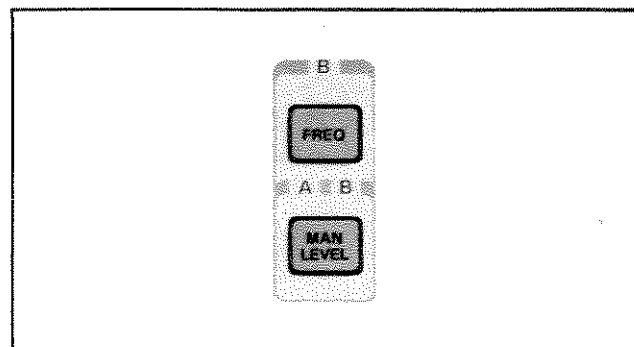

Figure 3-3. Front Panel B and A&B Function Keys

mode of operation for the B Channel input for display on the LCD. Channel B frequency range for the HP 5384A is 50 MHz to 225 MHz. Channel B frequency range for the HP 5385A is 90 MHz to 1000 MHz.

3-52. When channel B is selected, a black arrow appears in the bottom of the LCD over the "B" label located directly below the display window.

3-53. MAN LEVEL key enables or disables the front panel MANUAL TRIG LEVEL A/MANUAL ATTN LEVEL B control in the INPUTS section.

3-54. When the MAN LEVEL control is enabled (on), an arrow will appear in the LCD above the MAN LVL label. The trigger level of channel A becomes manually variable and the attenuation range becomes manually adjustable in Channel B.

3-55. When the MAN LEVEL control is disabled (off), the MANUAL TRIG LEVEL A/MANUAL ATTN LEVEL B control has no effect on input sensitivity of either channel. Channel A sensitivity is maximum (<10 mV rms) and Channel B sensitivity is controlled by an automatic gain circuit for improved noise rejection.

3-56. GATE and DISPLAY DIGITS

3-57. The GATE keys are shown in *Figure 3-4*. The GATE keys select the approximate gate time in decade ranges. The actual gate time is determined by the microcomputer.

3-58. The 0.1 s, 1.0 s, and 10 s keys select gate times from 0.1 second to 10 seconds for frequency, period and check measurements.

3-59. The greater the gate time the greater the accuracy and the number of digits of resolution you may obtain.

0.1 s 3 to 8 digits
1.0 s 3 to 9 digits
10 s 3 to 10 digits

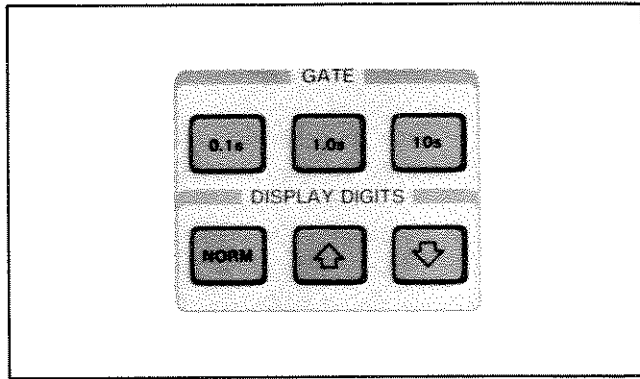

Figure 3-4. Front Panel GATE Select DISPLAY DIGITS Keys

If the most significant digits of a measurement are between 1.0 and 1.299... one extra digit is displayed, giving a maximum of 11 digits.

3-60. The DISPLAY DIGITS keys are shown in Figure 3-4. They select the number of digits displayed on the LCD. However, these keys do not affect the resolution of the measurement sent over the interface bus. Measurements are always sent with maximum resolution over the interface.

3-61. NORM key selects the normal display resolution of eight digits and a three letter units annunciation.

3-62. The measurement display will begin on the left of the LCD (character position 1) and occupy the eight leftmost character positions. The three rightmost digits (character positions 10, 11, and 12) are used for units annunciation. Character position nine is left blank.

Example: 10.000000 MHz.

3-63. \uparrow key will cause the number of digits displayed to increase to eight maximum for period measurements and 11 for frequency measurements. One press of the key causes one increment of digits displayed. When more than eight digits are displayed, the scale annunciation is reduced to only one character.

Example: 101.23456789M

3-64. This key will not affect the data sent over the interface. The counter will not display digits beyond the calculated LSD. That is, if you ask for 11 digit resolution, you may get 7, 8, 9, 10, or 11 digits.

3-65. \downarrow key will cause the number of digits displayed to decrease to a minimum of three digits. One

press of the key decreases the number of digits displayed by one digit.

6-66. Changes do not show on the display until completion of the next gate cycle, which could be up to 10 seconds. A new gate cycle is initiated when any key on the front panel is pressed. So, pressing any key on the front panel may cause a delay of up to 10 seconds before you will see the expected change in the display.

3-67. RESET/LOCAL and CHECK

3-68. The RESET/LOCAL and CHECK keys are shown in Figure 3-5.

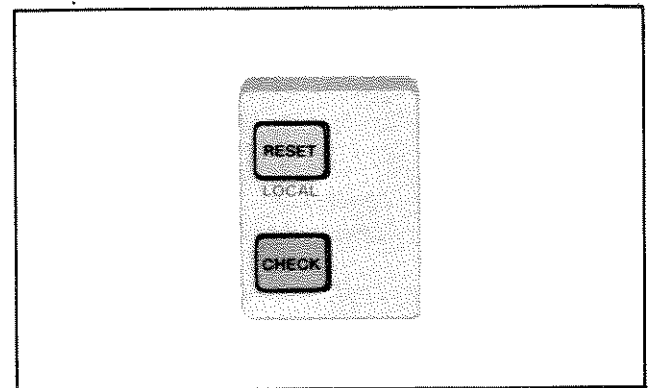

Figure 3-5. Front Panel RESET/LOCAL and CHECK Keys

3-69. When the counter is in the remote state and the local lockout (LLO) is not enabled, pressing the blue RESET/LOCAL key will return the counter to local keyboard control. The REM (remote) indicator arrow at the bottom left of the display will disappear. All functions and controls previously selected remain and a new measurement is initiated with the display reset to "00000000". If LLO is active, the RESET/LOCAL key as well as all other front panel keys are disabled.

3-70. If diagnostics are being executed while the counter is in either the local or remote state and the RESET/LOCAL key is pressed, the counter exits the diagnostic mode and defaults to the initialize mode of local operation.

3-71. If the counter is in local and not executing diagnostics, pressing the RESET/LOCAL key resets the display and initiates a new measurement.

3-72. The CHECK key is used to initiate tests that verify proper operation of the oscillator, shift register, microcomputer, display operation, and other hardware.

3-73. INPUTS

WARNING

DURING BATTERY OPERATION WITH THE MAINS POWER CORD DISCONNECTED FROM THE MAINS SUPPLY, THE FRONT AND REAR PANELS WILL FLOAT AT THE VOLTAGE APPLIED TO SIGNAL COMMON (INPUT BNC CONNECTOR SHELL). TO AVOID THE RISK OF ELECTRIC SHOCK DURING BATTERY OPERATION, ENSURE THE VOLTAGE APPLIED TO SIGNAL COMMON (BNC SHELL) DOES NOT EXCEED 42V PEAK.

3-74. The INPUTS section consists of two input BNC type connectors and a MANUAL TRIG LEVEL A/MANUAL ATTN LEVEL B single-turn potentiometer that controls the trigger level for channel A and manual attenuation for channel B. Figure 3-6 shows the INPUTS section.

3-75. Signals to be measured are connected to either channel A or channel B BNC connectors.

3-76. MANUAL TRIG LEVEL A/MANUAL ATTN LEVEL B is enabled or disabled by the MAN LEVEL key. When disabled, the MANUAL TRIG LEVEL A/MANUAL ATTN LEVEL B control has no effect on input sensitivity of Channel A or B. Channel A sensitivity is maximum and Channel B sensitivity is controlled by an automatic gain control circuit. After power-up, the control is automatically disabled (initialize mode).

3-77. When the MANUAL TRIG LEVEL A/MANUAL ATTN LEVEL B control is enabled, an arrow will appear on the LCD above the label MAN LVL. The DC offset level of Channel A input is manually variable. A variable DC offset has the effect of being a polarity and trigger level control. When the X20 ATTN is disabled, the trigger level of input A may be set from -0.1 volts to +0.1 volts peak. At midrange, 0.0 volt level, Channel A input sensitivity will be approximately 10 mV rms or ± 15 mV peak. If the X20 ATTN is enabled, these values increase by a nominal factor of 20.

3-78. When the MANUAL TRIG LEVEL A/MANUAL ATTN LEVEL B control is enabled, Channel B attenuation becomes manually variable. See the specifications in Section I.

3-79. There are two input BNC connectors; Channel A and Channel B. Channel A input frequency range is from 10 Hz to 100 MHz for the HP 5384A and HP 5385A. Channel B input frequency range is 50 MHz to 225 MHz for the HP 5384A and 90 MHz to 1.0 GHz for the HP 5385A. The input of the HP 5385A Channel B is protected by a fuse.

3-80. Both inputs are ac coupled with dc blocking up to 350 Vdc.

3-81. REAR PANEL FEATURES

3-82. A number of signal inputs, outputs, connectors and controls are provided on the rear panel.

3-83. The Input/Output interface connector provides optional remote control capabilities with either

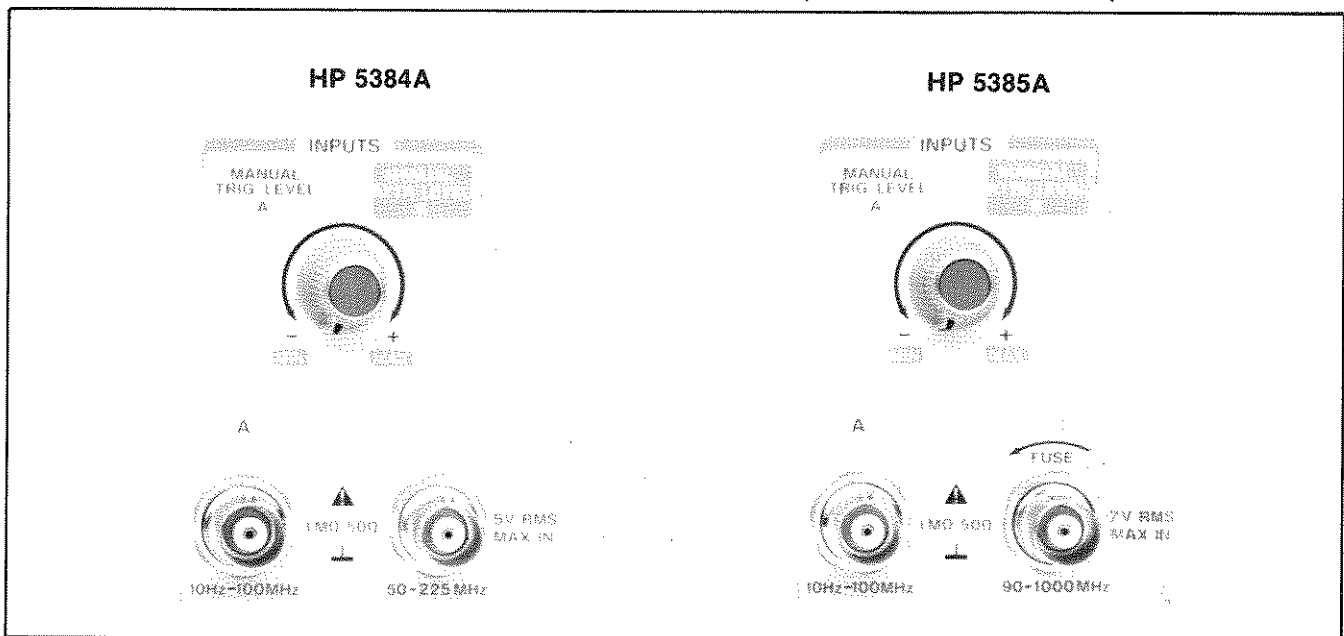

Figure 3-6. Front Panel INPUTS Section

the Hewlett-Packard Interface Bus (HP-IB) or the Hewlett-Packard Interface Loop (HP-IL). Option 003 is HP-IL.

3-84. The interface address switch (ADDR) is a seven-position switch that is used to manually set the remote control address of the counter. The five rightmost switch positions are externally accessible and can be used by the operator for setting the address. The two leftmost switch positions are not used for normal operation. For a complete description of address selection, refer to *Table 3-4, Address Selection*, in the Remote Programming Instructions in this section.

3-85. The HP-IB and HP-IL capabilities of the counter are listed above the interface port. For a complete description of the listed capabilities, refer to paragraph 3-118, *Interface Commands*.

3-86. The AC LINE INPUT connector accepts the ac input power cord. The protective grounding conductor also connects to the instrument through the ac power connector.

3-87. The LINE SELECT switch selects the instrument line voltage. The switch selects either 115 or 230 volts. The number visible on the switch indicates the nominal line voltage to which the instrument must be connected for proper operation.

3-88. The DC FUSE is a two-ampere fast-blow fuse for the protection of the dc power supply to the instrument. The dc fuse is the main protection for the counter. The fuse value should be two ampere 3AG fast-blow.

3-89. The EXT DC INPUT power connector accepts the two conductor dc input power cable. Input voltage range is from 9 volts to 15 volts dc and 1.0 ampere maximum. The EXT DC INPUT is fuse protected for a 2.0 ampere surge current.

3-90. The 10 MHz IN/OUT BNC connector provides a 10 MHz signal that may be used for calibration when the INT EXT switch is in the INT position. When the INT EXT switch is in the EXT position, the IN/OUT BNC connector becomes the external reference input for the counter.

3-91. EXTERNAL DC OPERATION

3-92. For external dc operation, connect the dc power cable to the EXT DC INPUT connector. Connect the other end to a dc power source of 9-15 volts and 500 mA minimum. If Option 005 battery pack is installed, the external dc power source should provide a minimum dc current of 700 mA to allow for battery charging.

3-93. MAKING FREQUENCY AND PERIOD MEASUREMENTS

WARNING

DURING BATTERY OPERATION WITH THE MAINS POWER CORD DISCONNECTED FROM THE MAINS SUPPLY, THE FRONT AND REAR PANELS WILL FLOAT AT THE VOLTAGE APPLIED TO SIGNAL COMMON (INPUT BNC CONNECTOR SHELL). TO AVOID THE RISK OF ELECTRIC SHOCK DURING BATTERY OPERATION, ENSURE THE VOLTAGE APPLIED TO SIGNAL COMMON (BNC SHELL) DOES NOT EXCEED 42V PEAK.

3-94. The recommended sequence for setting-up and making a measurement with the HP 5384A or HP 5385A Frequency counter is given below.

- a. Set the power switch to ON. The counter should perform a power-up self-check, then preset to the power-up initialize settings shown in *Table 3-1*.
- b. Press the key for the desired operating mode (frequency, period etc.).
- c. Connect a signal into the channel selected.
- d. If the display is unstable, use the attenuator, filter, or manual trigger level control and adjust for a stable reading. The above mentioned controls have limitations. They cannot compensate for excessively noisy or unstable signal sources.
- e. If desired, select a gate time and the number of display digits desired.

NOTE

The display for frequency measurements of less than Hertz will have a "less than" symbol (<) on the left of the Hertz symbol (Hz). Refer to *Table 3-3*.

Table 3-3. Units Display Format

FUNCTION	UNITS	
	<=8 DIGITS	>8 DIGITS
FREQUENCY A/ FREQUENCY B	< HZ HZ KHZ MHZ GHZ	< H K M G
PERIOD A	KSC SEC MS US NS	
CHECK	MHZ	M

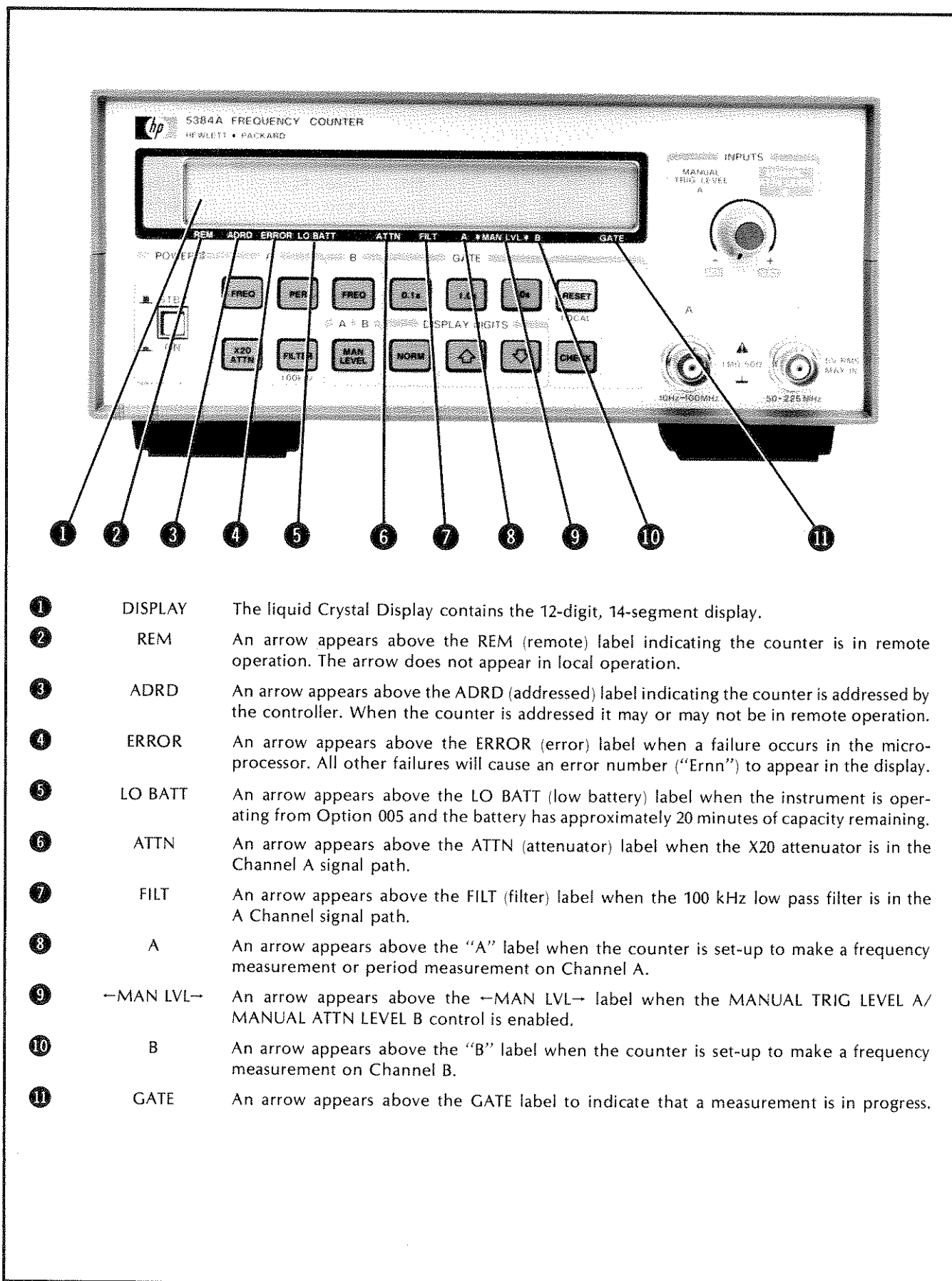

- ① **DISPLAY** The liquid Crystal Display contains the 12-digit, 14-segment display.
- ② **REM** An arrow appears above the REM (remote) label indicating the counter is in remote operation. The arrow does not appear in local operation.
- ③ **ADDR** An arrow appears above the ADDR (addressed) label indicating the counter is addressed by the controller. When the counter is addressed it may or may not be in remote operation.
- ④ **ERROR** An arrow appears above the ERROR (error) label when a failure occurs in the micro-processor. All other failures will cause an error number ("Ernn") to appear in the display.
- ⑤ **LO BATT** An arrow appears above the LO BATT (low battery) label when the instrument is operating from Option 005 and the battery has approximately 20 minutes of capacity remaining.
- ⑥ **ATTN** An arrow appears above the ATTN (attenuator) label when the X20 attenuator is in the Channel A signal path.
- ⑦ **FILT** An arrow appears above the FILT (filter) label when the 100 kHz low pass filter is in the A Channel signal path.
- ⑧ **A** An arrow appears above the "A" label when the counter is set-up to make a frequency measurement or period measurement on Channel A.
- ⑨ **←MAN LVL→** An arrow appears above the ←MAN LVL→ label when the MANUAL TRIG LEVEL A/ MANUAL ATTN LEVEL B control is enabled.
- ⑩ **B** An arrow appears above the "B" label when the counter is set-up to make a frequency measurement on Channel B.
- ⑪ **GATE** An arrow appears above the GATE label to indicate that a measurement is in progress.

Figure 3-7. Front Panel Indicators

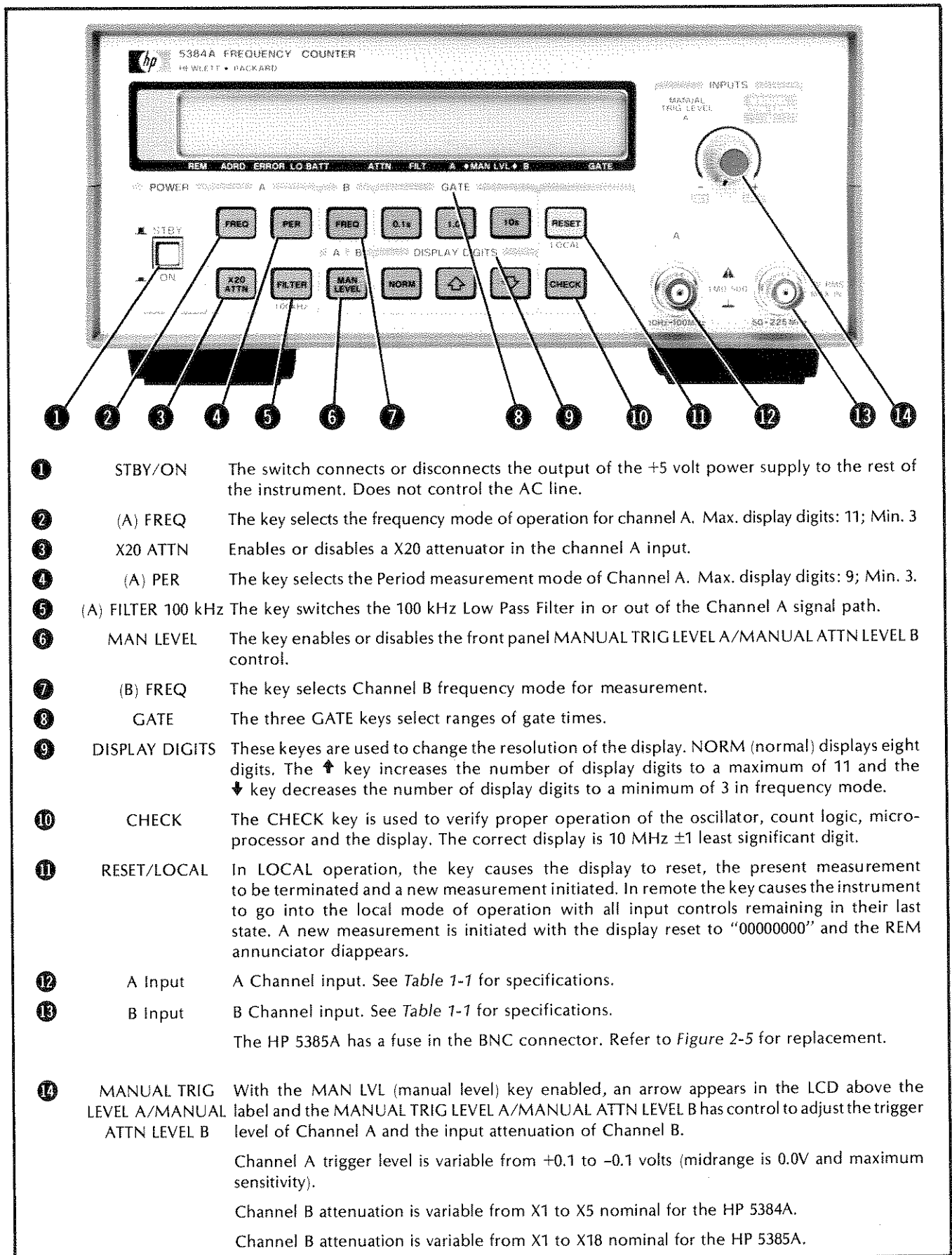

- 1** STBY/ON The switch connects or disconnects the output of the +5 volt power supply to the rest of the instrument. Does not control the AC line.
- 2** (A) FREQ The key selects the frequency mode of operation for channel A. Max. display digits: 11; Min. 3
- 3** X20 ATTN Enables or disables a X20 attenuator in the channel A input.
- 4** (A) PER The key selects the Period measurement mode of Channel A. Max. display digits: 9; Min. 3.
- 5** (A) FILTER 100 kHz The key switches the 100 kHz Low Pass Filter in or out of the Channel A signal path.
- 6** MAN LEVEL The key enables or disables the front panel MANUAL TRIG LEVEL A/MANUAL ATTN LEVEL B control.
- 7** (B) FREQ The key selects Channel B frequency mode for measurement.
- 8** GATE The three GATE keys select ranges of gate times.
- 9** DISPLAY DIGITS These keys are used to change the resolution of the display. NORM (normal) displays eight digits. The \uparrow key increases the number of display digits to a maximum of 11 and the \downarrow key decreases the number of display digits to a minimum of 3 in frequency mode.
- 10** CHECK The CHECK key is used to verify proper operation of the oscillator, count logic, micro-processor and the display. The correct display is 10 MHz \pm 1 least significant digit.
- 11** RESET/LOCAL In LOCAL operation, the key causes the display to reset, the present measurement to be terminated and a new measurement initiated. In remote the key causes the instrument to go into the local mode of operation with all input controls remaining in their last state. A new measurement is initiated with the display reset to "00000000" and the REM annunciator disappears.
- 12** A Input A Channel input. See Table 1-1 for specifications.
- 13** B Input B Channel input. See Table 1-1 for specifications.
The HP 5385A has a fuse in the BNC connector. Refer to Figure 2-5 for replacement.
- 14** MANUAL TRIG LEVEL A/MANUAL ATTN LEVEL B With the MAN LVL (manual level) key enabled, an arrow appears in the LCD above the label and the MANUAL TRIG LEVEL A/MANUAL ATTN LEVEL B has control to adjust the trigger level of Channel A and the input attenuation of Channel B.
Channel A trigger level is variable from +0.1 to -0.1 volts (midrange is 0.0V and maximum sensitivity).
Channel B attenuation is variable from X1 to X5 nominal for the HP 5384A.
Channel B attenuation is variable from X1 to X18 nominal for the HP 5385A.

Figure 3-8. Front Panel Controls

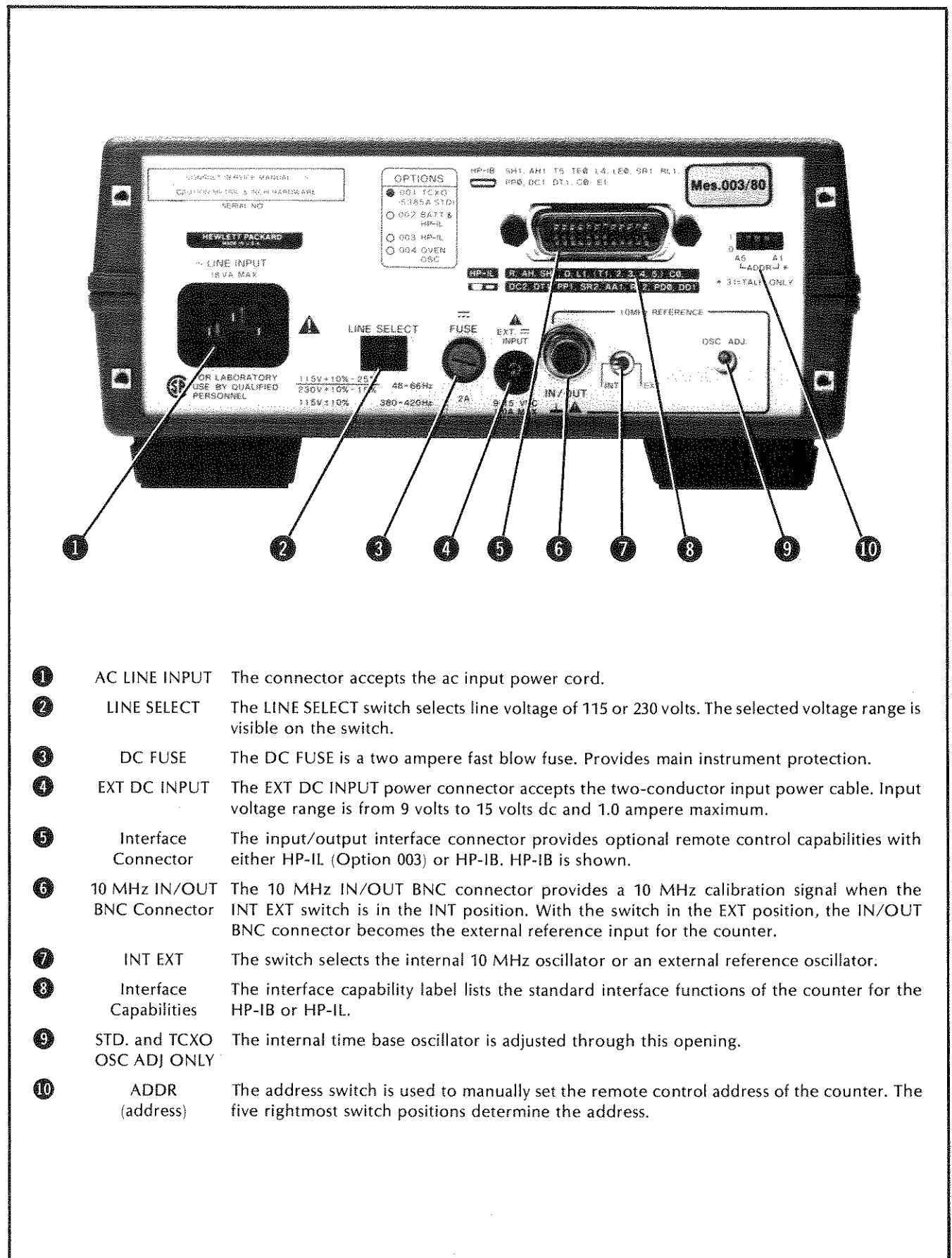

- ① AC LINE INPUT The connector accepts the ac input power cord.
- ② LINE SELECT The LINE SELECT switch selects line voltage of 115 or 230 volts. The selected voltage range is visible on the switch.
- ③ DC FUSE The DC FUSE is a two ampere fast blow fuse. Provides main instrument protection.
- ④ EXT DC INPUT The EXT DC INPUT power connector accepts the two-conductor input power cable. Input voltage range is from 9 volts to 15 volts dc and 1.0 ampere maximum.
- ⑤ Interface Connector The input/output interface connector provides optional remote control capabilities with either HP-IL (Option 003) or HP-IB. HP-IB is shown.
- ⑥ 10 MHz IN/OUT BNC Connector The 10 MHz IN/OUT BNC connector provides a 10 MHz calibration signal when the INT EXT switch is in the INT position. With the switch in the EXT position, the IN/OUT BNC connector becomes the external reference input for the counter.
- ⑦ INT EXT The switch selects the internal 10 MHz oscillator or an external reference oscillator.
- ⑧ Interface Capabilities The interface capability label lists the standard interface functions of the counter for the HP-IB or HP-IL.
- ⑨ STD. and TCXO OSC ADJ ONLY The internal time base oscillator is adjusted through this opening.
- ⑩ ADDR (address) The address switch is used to manually set the remote control address of the counter. The five rightmost switch positions determine the address.

Figure 3-9. Rear Panel Features

3-95. REMOTE PROGRAMMING

3-96. Introduction

3-97. The HP 5384A and HP 5385A frequency counters (with HP-IB) is compatible with the Hewlett-Packard Interface Bus, or (with Option 003) are compatible with the Hewlett-Packard Interface Loop. Remote programming allows the instrument to respond to remote control instructions and output measurement data via the interface. At the simplest level, the counter can output data in the talk only mode to other devices such as a printer. In more sophisticated systems, a controller can remotely program the counter to perform a specific type of measurement, trigger the measurement, and output the results.

NOTE

HP-IB is Hewlett-Packard's implementation of IEEE Std. 488-1978, "Standard Digital Interface for Programmable Instrumentation".

3-98. The programming information in this section, except where noted, applies to both HP-IB and HP-IL interfaces. In general, the HP-IB may be considered a subset of HP-IL, as almost all capabilities of the HP-IB are also capabilities of the HP-IL. Every effort has been made to make the programming of the counter consistent, regardless of which interface is configured.

3-99. To remotely program the counter efficiently, the operator must be familiar with the selected controller, the configured interface, and the local (manual) operation of the counter. Typical controllers for the HP-IB are the HP 9825A/B, HP 9826A, HP 9830A, HP 9835/45A, or HP 85A. Typical controllers for the HP-IL are the HP 85A and the HP 41CV. Users of the HP-IB interface should find the following manuals useful background information:

Condensed Description of the Hewlett-Packard Interface Bus (P/N 59401-90030)

HP-IB programming Hints for Selected Instruments (P/N 59300-90005)

Tutorial Description of the Hewlett-Packard Interface Bus (P/N 5952-0156)

3-100. Users of the HP-IL interface may be unfamiliar with the HP-IL system. An introductory description of the interface system, and the Hewlett-Packard Interface Loop (HP-IL) is provided later in this section. More detailed information on the HP-IL is available in the following publications:

HP-IL Interface Specification (P/N 82166-90017)

The HP-IL System: An Introductory Guide to the Hewlett-Packard Interface Loop (Published by OSBORN/McGraw-Hill, 630 Bancroft Way, Berkeley, CA 94710)

Product Note 5384A/5385A (P/N 02-5952-7700)

3-101. INTERFACE DESCRIPTION

3-102. Hewlett-Packard Interface Bus (HP-IB)

3-103. The Hewlett-Packard Interface Bus (HP-IB) system utilizes a party-line bus structure (devices share signal lines) to which a maximum of 15 devices may be connected in one continuous bus. Sixteen signal lines and 8 ground lines are used to interconnect devices in parallel arrangement and maintain an orderly flow of device and interface related information.

3-104. Hewlett-Packard Interface Loop (HP-IL)

3-105. The Hewlett-Packard Interface Loop (HP-IL) is a two-wire serial interface that provides programmable control of instruments while being easy to use and understand. The controller and all devices in the loop, including the counter, are connected together in series, forming a continuous loop communications circuit. Any information (instructions or data) that is transferred among HP-IL devices is passed from one device to the next around the loop (one direction only). If the information is not intended for a particular device, that device simply passes the information on to the next device in the loop. When the proper device receives the information, that device responds as directed. In this way, the controller or the counter can send information to and receive information from each device in the loop, according to the device's capability.

3-106. The counter may be connected anywhere in the interface loop. The loop consists of up to 30 devices plus the controller using simple addressing. When installing or removing the counter (or any other device) it is a good practice to turn off the controller first. Then simply disconnect the loop in one place and connect the counter at that point. Remember, the interface cables must form a continuous loop. All HP-IL connectors are designed to ensure proper orientation and indicate the direction of information transfer.



3-107. INTERFACE FUNCTIONAL OVERVIEW

3-108. Each device on the interface may possess one or more of the following major device capabilities: Controller, Talker, or Listener. The controller, as the name implies, has the responsibility to control interface activity. The controller, of course, must be equipped with the proper interface module. Controllers transmit all device independent commands to other devices in the interface and usually have Talker and Listener capabilities. The counter cannot serve as a controller.

3-109. Talkers are devices that have the ability to send data or device dependent commands through the interface. Note that a talker will not actually send its data or information until told to do so by the controller. The counter has Talker capabilities. In special situations, one device may be classified as a Talk-only device and sends information to Listen-only devices. Such a system would not have a controller. For example, the counter can be configured to the Talk-only mode and send measurement results to a printer. (TALK ONLY Address = 31).

3-110. Listeners are devices with the capability to receive information over the interface. Listeners must also be enabled by the controller to receive the information.

3-111. INTERFACE SYSTEMS TERMS

3-112. The following paragraphs define the terms and concepts used to describe HP-IB and HP-IL system operations.

- a. ADDRESS: Each device in the interface is assigned an address. The address is used to specify which device on the interface will receive information or send information.
- b. BYTE: A byte is a unit of information consisting of eight binary digits called bits.
- c. DEVICE: Any instrument or unit that is HP-IB or HP-IL compatible is called a device.
- d. DEVICE DEPENDENT: An action a device performs in response to information sent through the interface. The action is characteristic of a particular instrument and will probably vary from device to device.
- e. DEVICE INDEPENDENT COMMAND: A command predefined by the interface standard to have a specified bit pattern and resulting action.

f. DEVICE DEPENDENT COMMAND: A command not predefined by the interface standard, which is specific to a particular instrument or family of instruments.

g. POLLING: Polling is a process typically used by a controller to locate a device that has requested service from the controller. There are two types of polling; Serial Poll and Parallel Poll:

1. Serial Poll. When the controller executes a serial poll, the addressed device sends one byte of operational information called a status byte. If more than one device in the interface is capable of requesting service, each device on the interface must be serial polled until the device that requested service is located.
2. Parallel Poll. When the controller executes a parallel poll, all devices on the interface respond, each one setting or clearing a particular data bit to indicate whether or not it requested service.

3-113. ADDRESS SELECTION

3-114. MANUAL ADDRESSING. To use the counter in a system, set the rear panel address switches to the desired address. Addresses 0 through 30 represent the addressable mode range. Address 31 selects the Talk-only mode. The addressable mode is used when the counter functions as a talker and a listener. The TALK ONLY mode (Figure 3-10) is employed when the counter is operating in an output-only condition (no controller on the bus) and sends its data to another device on the bus, such as a printer, set to LISTEN ONLY.

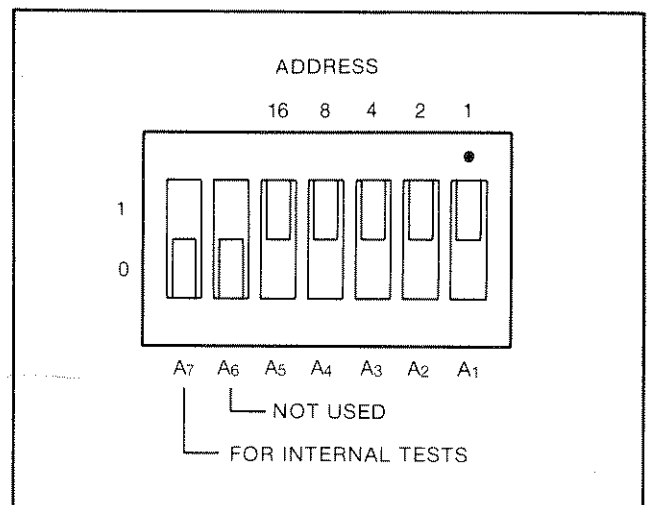

Figure 3-10. HP 5384A and HP 5385A Address Switches Shown in Address 31

3-115. The five rightmost switches, A₅ through A₁, set the address of the counter. Table 3-4 shows all possible address settings and the corresponding ASCII codes used by some controllers for talk and listen. The counter is factory set to address 03 as shown in Table 3-4. Address 21 is not allowed because that address is assigned to the controller device.

3-116. AUTOADDRESSING. Autoaddressing is a method of setting the instrument's address, unique to HP-IL, and is provided by the HP-85A, HP 41C/CV. When autoaddressing is enabled, each device in the loop is assigned an address by the controller. The assigned address will probably be different from the factory preset address. The counter, for example, has a preset address of 03. If the counter is the only device in the loop with the controller, the controller will assign it an address of "1". The address permits the controller to specify or select a particular device in the loop when sending commands. As shown in Figure 3-11, addresses are assigned to particular devices sequentially around the loop in the direction of information flow. The first device after the controller is assigned an address of "1". The second device is assigned the address of "2", and so on around the loop. The controller has an address of "0".

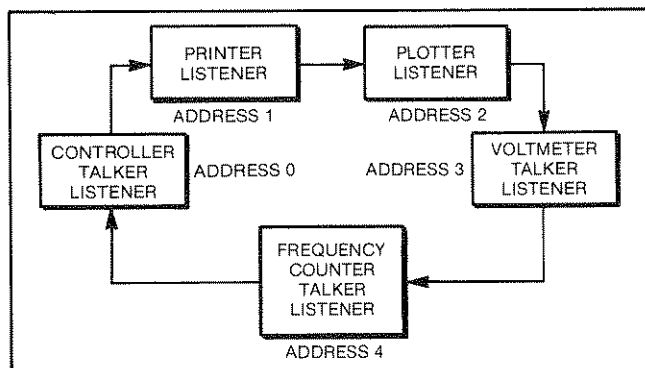

Figure 3-11. Typical HP-IL System Addressing

3-117. The interface status of the counter is indicated on the front panel by an arrow appearing above the REM ADDR labels on the front panel.

3-118. INTERFACE COMMANDS

3-119. The commands that the counter recognizes can be separated into two classes: device dependent commands and device independent commands. Device dependent commands are those that are unique to the instrument and are defined by the instrument designer. They are normally sent to an instrument as ASCII strings. A detailed description of device dependent commands begins in paragraph 3-138, Device Dependent Commands.

Table 3-4. Address Selection

Rear panel address switch:

(Shown in addressable mode, and address 03)

NOTE

*Select the decimal address from the table below and set the address switches to the corresponding positions.

ASCII CODE CHARACTER		ADDRESS SWITCHES					5-BIT DECIMAL CODE
LISTEN	TALK	A ₅	A ₄	A ₃	A ₂	A ₁	
SP	@	0	0	0	0	0	00
!	A	0	0	0	0	1	01
"	B	0	0	0	1	0	02
#	C	0	0	0	1	1	03
\$	D	0	0	1	0	0	04
%	E	0	0	1	0	1	05
&	F	0	0	1	1	0	06
'	G	0	0	1	1	1	07
(H	0	1	0	0	0	08
)	I	0	1	0	0	1	09
*	J	0	1	0	1	0	10
+	K	0	1	0	1	1	11
,	L	0	1	1	0	0	12
-	M	0	1	1	0	1	13
.	N	0	1	1	1	0	14
/	O	0	1	1	1	1	15
0	P	1	0	0	0	0	16
1	Q	1	0	0	0	1	17
2	R	1	0	0	1	0	18
3	S	1	0	0	1	1	19
4	T	1	0	1	0	0	20
5	U	1	0	1	0	1	21
6	V	1	0	1	1	0	22
7	W	1	0	1	1	1	23
8	X	1	1	0	0	0	24
9	Y	1	1	0	0	1	25
:	Z	1	1	0	1	0	26
;	[1	1	0	1	1	27
<	\	1	1	1	0	0	28
=]	1	1	1	0	1	29
>	~	1	1	1	1	0	30



3-120. Device independent commands, on the other hand, are defined by the interface standard document and are the same in all instruments. These commands are identified by a three letter mnemonic such as GTL, which represents Go to Local. Device independent commands are sent as specially encoded bytes on the interface and not as ASCII strings. Thus these commands cannot be sent using the OUTPUT statement on the HP-85A. However, many controllers do incorporate a command of the form SEND7;CMDnnn, where nnn is the decimal equivalent to the bit pattern corresponding to a particular device independent command.

3-121. INTERFACE CAPABILITIES

3-122. Since the device independent commands are standardized and are the same in all instruments, the functions these commands perform can be listed on the instrument in a standardized manner. This is known as the interface capability label.

HP-IB SH1, AH1, T5, TE0, L4, LE0, SR1, RL1, PP0, DC1, DT1, C0, E1

HP-IL R, AH, SH1, D, L1, (T1, 2, 3, 4, 5), C0, DC2, DT1, PP1, SR2, AA1, RL2, PD0, DD1

3-123. The number following the interface function code indicates the particular capability of that function.

3-124. Table 3-5 provides a list of the interface capabilities of the instrument.

3-125. META MESSAGES

3-126. In order to simplify the use of the HP-IB and HP-IL interfaces, HP has developed what is called the Meta Message concept. Rather than requiring the user to remember all the device independent messages and their interactions, useful sequences of these commands have been integrated into a single command on many of HP's controllers. For example, to clear the instrument at address 03 using the device independent commands, it is necessary to send the sequence ATN, UNL, MTA, LAD 03, SDC. In the HP-85, the command CLEAR 703 causes this sequence to be sent with no further user interaction. This greatly simplifies the use of the interface.

3-127. Many of the meta messages as implemented on the HP-85A may be sent in either of two forms, either with or without addressing. The form with addressing will normally listen address the instrument. For example, the command REMOTE 703 will

Table 3-5. Interface Capabilities

HP-IB	HP-IL	DESCRIPTION
SH1	SH1	The instrument can generate messages.
AH1	AH	The instrument can interpret received messages.
	R	The instrument can receive messages.
	D	The instrument can drive the HP-IL loop.
T5	T12345	The instrument can function as a talker. In addition, it can operate as a Talker Only instrument and can respond to serial poll, send device ID, and send accessory ID.
TE0		The instrument cannot function as an extended talker.
L4	L1	The instrument can function as a listener. It will accept commands via the interface. In addition, it will untalk itself if addressed as a listener.
LE0		The instrument cannot function as an extended listener.
SR1	SR2	The instrument can generate a service request. In addition, the instrument can generate an IDY frame on HP-IL.
RL1	RL2	The instrument can operate in both remote and local modes. In addition, it can respond to local lockout.
PP0	PP1	The instrument does not support parallel poll on HP-IB. On HP-IL, the instrument does support parallel poll.
DC1	DC2	The instrument supports both the device clear (DCL) and selected device clear (SDC) commands.
DT1	DT1	The instrument can be remotely triggered.
C0	C0	The instrument cannot function as a controller.
	AA1	The instrument can be remotely addressed with simple (non-extended) addresses.
	PD0	The instrument cannot be remotely powered down.
	DD1	The instrument responds to the device dependent listener (DDL) command.
E1		The instrument places one load on the HP-IB system.

send REN and then make the instrument a listener. In the following tables, the form with addressing is shown.

3-128. Table 3-6 lists the meta messages, their results in the counter, and typical interface message sequences corresponding to them. The sequences are typical in that different controllers may send different sequences, while still obtaining the same results.



Table 3-6. Meta Messages

MESSAGE	DESCRIPTION/RESPONSE
DATA	A means to send device dependent command and receive measurement data. HP-IB: UNL, MTA, LADn, data HP-IL: UNL, MTA, LADn, SDA, data
TRIGGER	Starts a new measurement.
CLEAR	Will clear the display. If in error state, clears error only. UNL, MTA, LADn, SDC
REMOTE	Disables front panel keys (except for Reset/Local). REN, UNL, MTA, LADn
LOCAL	Enables the front panel keys. UNL, MTA, LADn, GTL
LOCAL and CLEAR LOCKOUT	Enables the front panel keys and clears Local Lockout. HP-IB: REN HP-IL: NRE
LOCAL LOCKOUT	Disables the Reset/Local key when in remote. LLO
SERVICE REQUEST	This command is ignored when received by the instrument. It will be sent by the instrument when an enabled service condition is present.
STATUS BYTE	Presents status information. HP-IB: UNL, MLA, TADn, SPE, data, SPD, UNT HP-IL: UNL, MLA, TADn, SST, data, UNT
STATUS BIT	Single bit parallel poll response indicates whether this instrument is requesting service. IDY
PASS CONTROL	Not supported.
ABORT	Terminates bus communications by unlistening and untalking all instruments. IFC
DEVICE ID	Causes the instrument to send the string "HP 5384A" or "HP 5385A" UNL, MLA, TADn, SDI, data
ACCESSORY ID	Causes the instrument to send the number 81 in binary. This identifies the instrument as a measuring instrument. UNL, MLA, TADn, SAI, data

3-129. Table 3-7 lists the meta messages and the HP 9825, HP-85, and HP-41C commands that correspond to them. (Only the addressed form is shown for the commands that support both the unaddressed and addressed forms. The HP-41C requires the address selection to be made using a SELECT statement.) The table assumes the instrument is set to address 03 and the interface to select code 7.

Table 3-7. Meta Messages and Controller Commands

MESSAGE	HP 9825	HP-85	HP-41C
DATA	wrt 703, A\$ red 703, A\$	OUTPUT 703; A\$ ENTER 703; A\$	OUTA INA
TRIGGER	trg 703	TRIGGER 703	TRIGGER
CLEAR	clr 703	CLEAR 703	
REMOTE	rem 703	REMOTE 703	REMOTE
LOCAL	lcl 703	LOCAL 703	LOCAL
LOCAL/CLEAR LOCKOUT	lcl 7	LOCAL 7	
LOCKOUT	llo 7	LOCAL LOCKOUT 7	
SERVICE REQUEST		STATUS 7,1; A	
STATUS BYTE	rds (703)	SPOLL (703)	INSTAT
*STATUS BIT		PPOLL (7)	
PASS CONTROL			
ABORT	cli 7	ABORTIO 7	STOPIO
*DEVICE ID		SEND 7; CMD 255	FINDID
*ACCESSORY ID		SEND 7; CMD 254	

*HP-IL only.
Typically, HP-IL uses an address code of 9nn and HP-IB uses an address code of 7nn.

3-130. SRQ, SRQ MASK, AND STATUS BYTE

3-131. SRQ and Status Byte

3-132. When in remote operation, the counter can send a service request (SRQ) to the controller to indicate the need for attention and can act as an interrupt to the current sequence of events. Typically, SRQ indicates data is ready to transmit and/or an error condition exists. The counter can send an SRQ to the controller under any, all, or none of the following conditions, as defined by the Service Request Mask. The Service Request Mask (SM command) must be set prior to the condition. Refer to paragraph 3-136.

- a. DATA READY. A measurement has been completed and is available for collection.
- b. ERROR. An Error or Failure condition exists, and is displayed.
- c. LOCAL. The instrument is in local.



state. In the normal state, measurements are made continuously regardless of whether or not those measurements were read by the controller.

3-152. DR (string) Remote Display

3-153. The remote display command is legal only when the counter is in the measurement mode. If the command is received while the counter is in the diagnostic mode, an error will be flagged.

3-154. The remote display command allows the user to send any message, 12 characters in length excluding punctuation, to the LCD. A punctuation mark (comma, colon, or decimal point) can be sent between each of the characters.

3-155. Although the counter will continue making measurements, the LCD will contain the message sent with the "DR" command rather than the measurement data.

3-156. Whenever a new message is to be displayed, the remote display command must be sent. Thus each new message must be sent in the form "DRXXXXXXXX", where the X's represent the message to be displayed. Carriage return, line feed, form feed, horizontal tab, and vertical tab can be used as terminators for a remote display message. A message sent to the display will remain there until a command which causes a change in the display is sent to the counter.

3-157. The remote display mode can be terminated in several ways. Sending a "DL" (display local) command will terminate the remote display mode without changing the state of the counter in any other way. When the counter receives this command, it will clear the display and resume displaying measurement data. Sending a diagnostic command also terminates the remote display mode, but it causes the counter to exit the measurement mode as well. Pressing the RESET/LOCAL key is another way of terminating the remote display mode, however, the key will cause the counter to exit the remote state and enter the local state. Any transition from the remote state to the local state, caused by the controller, will terminate the remote display mode as well.

3-158. If an error condition is generated while the instrument is in the remote display mode, the error message will be displayed just as in any other case. However, when the error is cleared, the counter will no longer be in the remote display mode; it will begin

displaying the measurement data rather than the message contained in the LCD prior to the error condition.

3-159. DL Display Local

3-160. The display local command allows the user to terminate the remote display mode without changing the state of the counter in any other way. When the counter receives this command, it will clear the remote display message and begin displaying measurement data.

3-161. ID and SI Send Device ID

3-162. These two commands perform the same function. Whenever the counter receives either of these two commands, it will send its ID to the controller. Either "HP 5384A" or "HP 5385A" will be sent to the controller. The counter will wait until the device ID is read by the controller before it will resume taking measurements again.

3-163. SE Send Error

3-164. When the send error command is received, the instrument will send the number of the detected error (there may be more than one) to the interface bus. We recommend the "SE" command be used in a string by itself.

3-165. LCD Character Set

3-166. Table 3-10 shows the characters the instrument can produce. Included in the table is a code needed to produce the character and how the displayed character will look.

3-167. PROGRAM EXAMPLES

3-168. The following examples demonstrate programming capabilities of the HP 5384A and HP 5385A. The first four examples are written for the HP-85A controller. The fifth example is written for the HP 41C/CV. A summary of the program operation and a line-by-line description are provided for each example.

- Example 1 Instrument Identification
- Example 2 Reading Status Byte
- Example 3 Frequency A
- Example 4 Remote Display
- Example 5 Frequency A Measurement

EXAMPLE 1. INSTRUMENT IDENTIFICATION

The following example demonstrates how to display the identification address of the counter on the display screen of the controller. The program clears the HP 5384A/HP 5385A then requests the instrument identification. The response is read into "N\$", which is then displayed. Note: To use this example with an HP 5385A, substitute HP 5385A wherever HP 5384A is entered.

PROGRAM

```

10 REM      Example #1: INSTRUMENT IDENTIFICATION   "TAR1"
20 CLEAR @ DISP USING "5/"
30 DISP " Searching for 5384A address... " @ DISP
40 N$="NOT 5384A"
50 FOR S=700 TO 730
60 IF S=721 THEN 140
70 DISP S @ BEEP 250,75
80 SET TIMEOUT 7;100
90 OUTPUT S ;"ID"
100 ENTER S ; N$
110 IF N$="HP5384A" THEN 230
120 CLEAR S
130 ABORTIO 7
140 NEXT S
150 BEEP 200,200
160 CLEAR @ DISP USING "5/"
170 DISP "Address not found." @ DISP
180 DISP "Verify HP-IB connection and that the 5384A is not in the TALK"
190 DISP "ONLY mode."
200 DISP @ DISP "Press 'CONT' when ready."
210 PAUSE
220 GOTO 20
230 DISP @ BEEP @ DISP " HP 5384A FOUND AT ADDRESS";S;"!"
240 END

```

PROGRAM DESCRIPTION

- Line 10 Remarks; comments only, does not affect the program.
- Line 20 Clears the controller display only and places the cursor near the middle of the controller display screen.
- Line 30 Message inside quotes is displayed on controller display screen and the cursor skips one line.
- Line 40 Set "N\$" equal to "not 5384A".
- Line 50 Loop "S" from address 700 to 730
- Line 60 If instrument value = 721 (calculator address) then go to line 140.
- Line 70 Display instrument address and beep. The number "75" determines the length of time of the beep and "250" determines the pitch.
- Line 80 Set time out on address 7 to 100 ms.
- Line 90 Send "ID" command to instrument with address = to "S".
- Line 100 Read instrument "ID" response into "N\$".
- Line 110 If contents of "N\$" equals "5384A", then jump to line 230.
- Line 120 Clear instrument at address "S".
- Line 130 Terminates any data transfer on address 7.
- Line 140 Increment to next address.
- Line 150 Beep.
- Line 160 Clears controller display only and places the cursor near the middle of the controller display.
- Line 170 Display string within quotes on the controller display and skip on line.
- Line 180 Display string within quotes on controller screen.
- Line 190 Display string within quotes on controller screen.
- Line 200 Skip one line and display string within quotes on controller display.
- Line 210 Halt program until user presses "CONT".
- Line 220 Go to line 20.
- Line 230 Skip a line, beep and display string within quotes and the address of HP 5384A.
- Line 240 End program execution.



EXAMPLE 2. READING STATUS BYTE

The following example reads the status byte of the HP 5384A/HP 5385A by a serial poll at address 03. The value returned is input into "A". The program first displays the status byte prior to the error condition. After the error condition is generated by sending an illegal command "FU5", the program again displays the status byte of a different value.

PROGRAM

```
10 REM      Example #2:  READING STATUS BYTE           "TAR2"
20 S=703
30 CLEAR @ DISP USING "3/"
40 OUTPUT S ;"SM5"
50 A=SPOLL(S)
60 DISP "The value of the status byte      prior to the error condition is"
70 DISP "equal to";A;"."
80 DISP
90 DISP "Press 'CONT' to generate an SRQ and alter the status byte value."
100 DISP @ PAUSE
110 BEEP
120 OUTPUT S ;"FU5"
130 A=SPOLL(S)
140 DISP "The value of the status byte      after the error condition is"
150 DISP "equal to";A;"."
160 END
```

PROGRAM DESCRIPTION

- Line 10 Remarks; comments only, does not affect the program.
- Line 20 Set "S" = to 703.
- Line 30 Clears the controller display only and the cursor skips three lines. The reason for skipping 3 lines is simply to bring the cursor near the middle of the display screen.
- Line 40 Send service request mask to HP 5384/HP 5385 at address equal to "S" for error or failure condition or data ready condition.
- Line 50 Read status of HP 5384A/HP 5385A (into A) by a serial poll at address equal to "S".
- Line 60 Display message within quotes.
- Line 70 Display message within quotes and the status byte.
- Line 80 Skip one line on controller screen.
- Line 90 Display message within quotes.
- Line 100 Skip one line on controller screen and halt program execution until user presses "CONT".
- Line 110 Beep.
- Line 120 Output "FU5" command to HP 5384A/HP 5385A at address "S" ("FU5" will generate an error condition).
- Line 130 Read the status of HP 5384A/HP 5385A (into A) by a serial poll at address "S".
- Line 140 Display message within quotes.
- Line 150 Display message within quotes and status byte.
- Line 160 End program execution.



EXAMPLE 3. FREQUENCY A

The following example demonstrates how to display a Frequency A measurement on the controller display screen. The address is set to 03 and the "IN" command is sent to the HP 5384A/HP 5385A. The response is read into "A\$", which is then displayed.

PROGRAM

```
10 REM Example #3: FREQUENCY A "TAR3"  
20 S=703  
30 OUTPUT S ;"IN"  
40 ENTER S ; A$  
50 DISP "FREQUENCY A =" ;A$[2]  
60 GOTO 30  
70 END
```

PROGRAM DESCRIPTION

- Line 10 Remarks; comments only, does not affect the program.
- Line 20 Set "S" equal to 703.
- Line 30 Output "IN" command to HP 5384A/HP 5385A at address "S".
- Line 40 Read HP 5384A/HP 5385A response into "A\$".
- Line 50 Display "Frequency A="; followed by the contents of the second character onward of "A\$".
- Line 60 Go to line 30.
- Line 70 End program execution.

EXAMPLE 4. REMOTE DISPLAY

The following example demonstrates how to send messages to the display of the counter. The program sets the address to 03 then sends a message to the display of the counter.

PROGRAM

```
10 REM Example #4 REMOTE DISPLAY "TAR4"  
20 S=703  
30 OUTPUT S ;"DR HP 5384A"  
40 END
```

PROGRAM DESCRIPTION

- Line 10 Remarks; comments only, does not affect the program.
- Line 20 Set "S" equal to 703.
- Line 30 Send remote display message (HP 5384A/HP 5385A) to instrument at address "S".
- Line 40 End program execution.

EXAMPLE 5. FREQUENCY A MEASUREMENT

The following example demonstrates how to display a Frequency A measurement on the display (X register) of the HP-41C/CV. Included in the example are the keystrokes required to program the HP-41C/CV.

The following program initializes the counter (locates the counter in the loop and sets the counter to Remode mode). After initialization, the program sends instructions to measure the frequency at Input A, set up a gate time of one second, enable the 100 kHz Low Pass Filter, and send the measurement back to the display of the HP-41C/CV.

For the example, use the set-up shown in *Figure 3-12, Example 5 Set-Up*, and make the following adjustments.

1. Set a signal generator to a sine wave frequency of $500 \text{ kHz} \pm 10 \text{ kHz}$.
2. Set an output level of $250 \text{ mV} \pm 100 \text{ mV}$.
3. Connect the signal generator to Input A of the HP 5384A/HP 5385A.
4. Cycle the HP 5384A/HP 5385A counter from STBY to ON.
5. Press the INPUT B key.

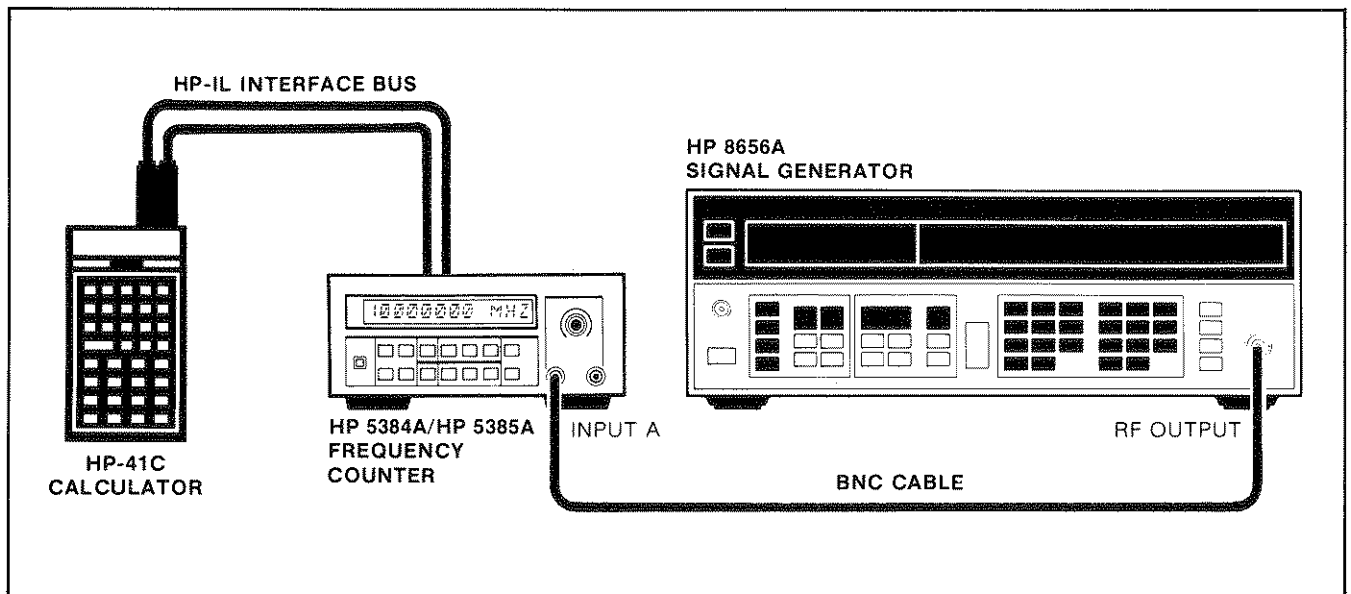

Figure 3-12. Example 5 Set-Up

Use the following keystrokes to:

1. Program the HP-41C/CV to perform the Frequency A measurement.
2. Execute the program.

NOTE: Clear Memory First.

HP 41C/CV	HP 41C/CV DISPLAY
1. <input type="button" value="PRGM"/>	PRGM
2. <input type="button" value="GTO"/> <input type="button" value="•"/> <input type="button" value="•"/>	PRGM
3. <input type="button" value="LBL"/> <input type="button" value="ALPHA"/> IN <input type="button" value="1"/> <input type="button" value="8"/> <input type="button" value="4"/> <input type="button" value="ALPHA"/>	PRGM
4. <input type="button" value="XEQ"/> <input type="button" value="ALPHA"/> IND <input type="button" value="ALPHA"/>	PRGM
5. <input type="button" value="CF"/> 17	PRGM
6. <input type="button" value="ALPHA"/> HP <input type="button" value="5"/> <input type="button" value="3"/> <input type="button" value="8"/> <input type="button" value="4"/>	PRGM
7. <input type="button" value="XEQ"/> <input type="button" value="ALPHA"/> FINDID <input type="button" value="ALPHA"/>	PRGM
8. <input type="button" value="ALPHA"/> FU <input type="button" value="1"/> GA <input type="button" value="2"/> FI <input type="button" value="1"/>	PRGM
9. <input type="button" value="XEQ"/> <input type="button" value="ALPHA"/> OUTA <input type="button" value="ALPHA"/>	PRGM
10. <input type="button" value="XEQ"/> <input type="button" value="ALPHA"/> IND <input type="button" value="ALPHA"/>	PRGM
11. <input type="button" value="GTO"/> <input type="button" value="•"/> <input type="button" value="•"/>	PRGM
12. <input type="button" value="PRGM"/>	PRGM
13. <input type="button" value="ASN"/> <input type="button" value="ALPHA"/> IN <input type="button" value="1"/> <input type="button" value="8"/> <input type="button" value="4"/> <input type="button" value="ALPHA"/>	PRGM
14. <input type="button" value="LN"/>	PRGM
15. <input type="button" value="USER"/>	PRGM
16. <input type="button" value="LN"/>	PRGM

NOTE: All shaded keys represent the gold shift key on the HP 41C/CV.

PROGRAM DESCRIPTION

- Step 1 The program (PRGM) key places the HP 41C/CV into the programming mode. Keystrokes are recorded as programming instructions. The PRGM annunciator appears in the display.
- Step 2 The GTO key places the HP 41C/CV at the end of program memory and inserts the END instruction if it is not present. The HP 41C/CV displays the number of registers left in program memory.
- Step 3 The Label (LBL) key labels the program with the name "IN184". The ALPHA key toggles the HP 41C/CV into and out of ALPHA mode to enter letters in the program name. Press the gold shift key before keying each number.
- Step 4 The Execute (XEQ) command followed by the Auto input/output (AUTOIO) command, sets up the loop so the interface automatically searches for the proper device to carry out the operations of the program.
- Step 5 Flag 17 is cleared. Flag 17 controls how the HP-IL module uses the standard end-of-line indicator; Carriage Return (CR) and Line Feed (LF).
- Step 6 The name of the device the interface will search for is entered here.
- Step 7 The Execute (XEQ) command followed by the Find Identity (FINDID) command causes the interface to search for the HP 5384A and determine the address of the device on the loop.
- Step 8 The command codes that cause the counter to make the Frequency A measurement, set the gate time to one second and enable the 100 KHz low pass filter are entered into the ALPHA register.
- Step 9 The Execute (XEQ) command followed by the Output A (OUTA) command causes the contents of the ALPHA register to be sent to the counter.
- Step 10 The Execute (XEQ) command followed by the Input Decimal (IND) command causes the counter display (X register) of the HP 41C/CV.
- Step 11 The GTO command places an END statement at the end of the program. The display will show how many registers are left in program memory.
- Step 12 The program (PRGM) key toggles the HP 41C/CV out of the program mode.
- Step 13 The Assign (ASN) key will assign the program "IN184" to a key location on the HP 41C/CV keyboard.
- Step 14 The LN key is the key location selected for the program "IN184". The assigned key location 1, 5, (Row 1, Column 5) is briefly displayed at the right side of the display.
- Step 15 The USER key toggles the HP 41C/CV into the USER mode for access to the programs called up by the various key locations.
- Step 16 The LN key in the USER mode executes the program "IN184". Program execution is indicated by a  symbol moving across the display from left to right.



Table 3-10. LCD Character Set

LCD CHAR.	ASCII CHAR.	DECIMAL	LCD CHAR.	ASCII CHAR.	DECIMAL	LCD CHAR.	ASCII CHAR.	DECIMAL
␣	NULL, @	0, 64	␣	SYNC, V	22, 86	,	,	44
␣	SOH, A	1, 65	␣	ETB, W	23, 87	␣	—, m	45, 109
␣	STX B	2, 66	␣	CAN, X	24, 88	␣	·	46,
␣	EXT, C	3, 67	␣	EM, Y	25, 89	␣	/, o	47, 111
␣	EOT, D	4, 68	␣	SUB, Z	26, 90	␣	0, p	48, 112
␣	ENQ, E	5, 69	␣	ESC,	27, 91	␣	1, q	49, 113
␣	ACK, F	6, 70	␣	FS, \	28, 92	␣	2, r	50, 114
␣	BELL, G	7, 71	␣	GS,]	29, 93	␣	3, s	51, 115
␣	BS, H	8, 72	␣	RS, ^	30, 94	␣	4, t	52, 116
␣	HT, I	9, 73	␣	US, _	31, 95	␣	5, u	53, 117
␣	LF, J	10, 74	␣	space	space, `	␣	6, v	54, 118
␣	VT, K	11, 75	␣	!	!, a	␣	7, w	55, 119
␣	FF, L	12, 76	␣	"	", b	␣	8, x	56, 120
␣	CR, M	13, 77	␣	#	#, c	␣	9, y	57, 121
␣	SO, N	14, 78	␣	\$	\$, d	␣	z	122
␣	SI, O	15, 79	␣	%	%, e	␣	:	58, 122
␣	DLE, P	16, 80	␣	&	&, f	␣	;	59, 123
␣	DC1, Q	17, 81	␣	'	', g	␣	<,	60, 124
␣	DC2, R	18, 82	␣	((, h	␣	=, }	61, 125
␣	DC3, S	19, 83	␣)), i	␣	>, ~	62, 126
␣	DC4, T	20, 84	␣	*	*, j	␣	?, DEL	63, 127
␣	NAK, U	21, 85	␣	+	+, k	␣	l	108
						␣	n	110

SECTION IV PERFORMANCE TESTING

4-1. INTRODUCTION

4-2. The procedures in this section provide two types of tests. First, a complete performance test for the HP 5384A and HP 5385A Frequency Counters. They can be performed without access to the interior of the instrument. The second test is an HP-IB verification test using the HP85A controller.

4-3. EQUIPMENT REQUIRED

4-4. Equipment required for complete test and operation verification is listed in *Table 1-2*. Any equipment which satisfies the critical specifications given in the table may be substituted for the recommended model numbers.

4-5. TEST RECORD

4-6. Results of the complete performance test should be recorded on a copy of the Performance Test Card at the end of this section.

4-7. ERROR MESSAGES

4-8. Under certain conditions the counter will display Error messages. Error messages typically occur during the power-up, initialize cycle. These messages indicate a hardware failure or the user has attempted an improper operation, either through the keyboard or the interface.

4-9. Performance Test

4-10. The performance test is given in *Table 4-1*. The performance test verifies all specifications listed in *Table 1-1*. All tests can be performed without access to the interior of the instrument.

Table 4-1. Performance Test

I. POWER-UP CHECK

Description:

The HP 5384A/HP 5385A Frequency Counter power is set to STBY, then on. The counter will be cycled through its power-up, initialize subroutine. This test is performed with no external time base signal applied to the counter. A test is made of all the major function blocks, then goes to its initialize state.

a. Set-up:

Insure that no cables are connected to input A or to the interface connector. Cycle the POWER switch from STBY to ON.

b. Verify the following:

1. A display "starburst" is shown in all 12-character positions for about one second.
2. The selected address of the instrument interface is displayed for about one second.
3. The display shows "00000000" and an arrow appears over the "A" for "A" channel.

c. Record the result on the test card (Pass/Fail).

II. CHANNEL A FREQUENCY RESPONSE AND SENSITIVITY TEST (HP 5384A/HP 5385A)

Description:

A signal generator with a calibrated output is set to the specified HP 5384A/HP 5385A channel A minimum signal sensitivity level. The frequency is slowly increased from 10 Hz up to 20 MHz at a constant level. The HP 5384A/HP 5385A reading is checked for the proper count. For the range of 20 MHz to 100 MHz, a different generator is used.

Table 4-1. Performance Test (Continued)

Specifications: 10 Hz to 100 MHz:

- 25 mV rms, sinewave, 10 Hz to 50 Hz
- 15 mV rms, sinewave, 50 Hz to 100 MHz

a. 10 Hz to 50 Hz:

1. Connect the HP 3325A synthesizer/function generator to HP 5384A/HP 5385A A channel input as shown in Figure 4-1.

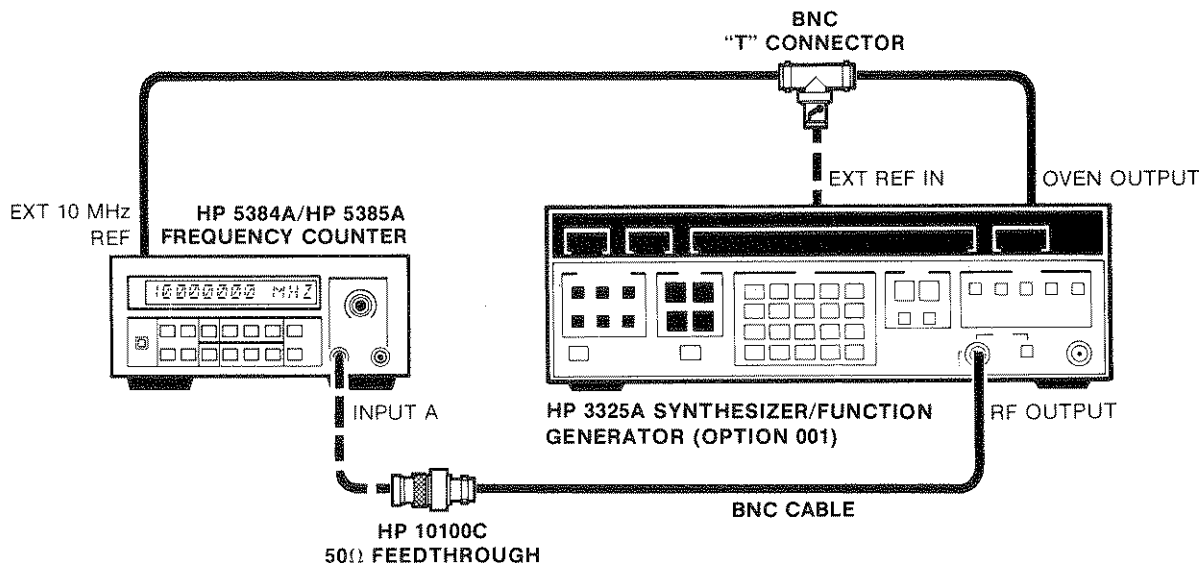

Figure 4-1. Channel A Frequency Response and Sensitivity Test Setup (HP 5384A/HP 5385A)

2. Set the HP 3325A to output a 10 Hz sinewave at 25 mV rms. Increase the frequency of the HP 3325A and verify the HP 5384A/HP 5385A displays the proper frequency from 10 Hz to 50 Hz. Record the results on the test card (Pass/Fail).
- b. 50 Hz to 20 MHz
1. Use the same set-up shown in Figure 4-1.
 2. Set the HP 3325A to output a 50 Hz sinewave at 15 mV rms. Increase the frequency of the HP 3325A and verify the HP 5384A/HP 5385A displays the proper frequency from 50 Hz to 20 MHz. Record the results on the test card (Pass/Fail).
- c. 20 MHz to 100 MHz
1. Connect the HP 8656A Signal Generator to the HP 5384A/HP 5385A A channel input as shown in Figure 4-2.

Table 4-1. Performance Test (Continued)

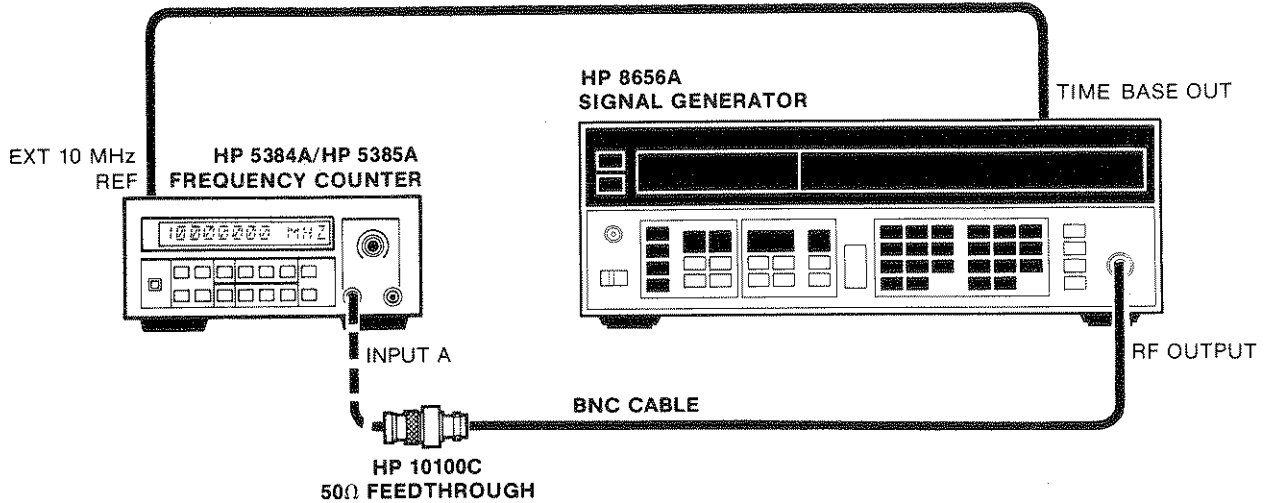

Figure 4-2. Channel A Frequency Response and Sensitivity Test Setup for HP 5384A/HP 5385A

2. Set the HP 8656A to output a 20 MHz sinewave at 15 mV rms. Increase the frequency of the HP 8656A and verify the counter displays the proper frequency from 20 MHz to 100 MHz. Record the results on the test card (Pass/Fail).

III. CHANNEL B FREQUENCY RESPONSE AND SENSITIVITY TEST FOR HP 5384A

Description:

A signal generator with a calibrated output is set to the specified HP 5384A channel B minimum signal sensitivity level. The frequency is slowly increased from 50 MHz up to 225 MHz at a constant level, and the HP 5384A reading is checked for the proper count.

Specifications: 50 MHz to 225 MHz:

10 mV rms, sinewave, 50 MHz to 200 MHz

15 mV rms, sinewave, 200 MHz to 225 MHz

- a. 50 MHz to 200 MHz

1. Connect the HP 8656A signal generator to the HP 5384A B channel input as shown in Figure 4-3.

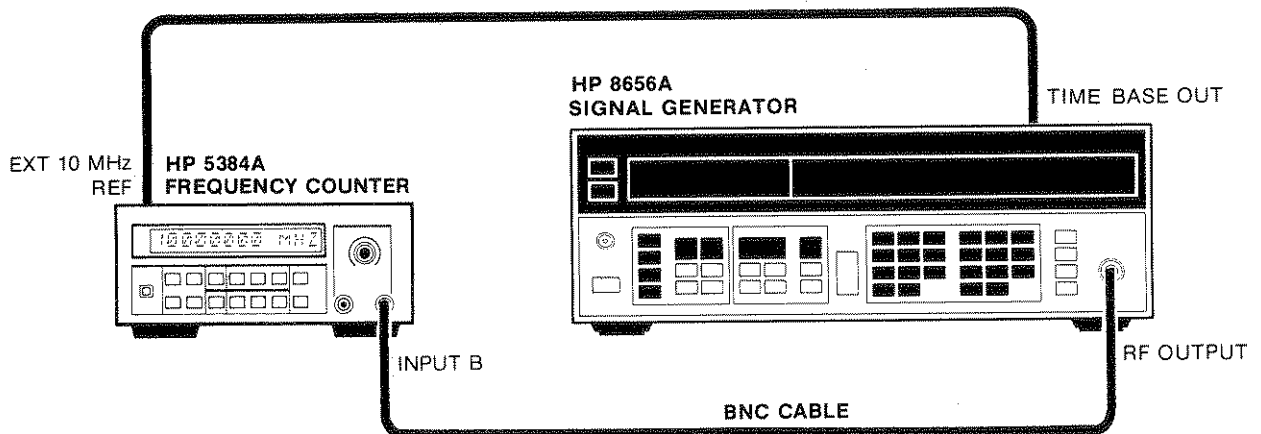

Figure 4-3. Channel B Frequency Response and Sensitivity Test Setup for HP 5384A

Table 4-1. Performance Test (Continued)

2. Set the HP 8656A to output a 50 MHz sinewave at 10 mV rms. Select frequency B on the HP 5384A. Increase the frequency of the HP 8656A and verify that the HP 5386A displays the proper frequency from 50 MHz to 200 MHz. Record the results on the test card (Pass/Fail).
- b. 200 MHz to 225 MHz
1. Set the HP 8656A to output a 200 MHz sinewave at 15 mV rms. Increase the frequency of the HP 8656A and verify that the HP 5384A displays the proper frequency from 200 MHz to 225 MHz. Record the results on the test card (Pass/Fail).

IV. CHANNEL B FREQUENCY RESPONSE AND SENSITIVITY TEST FOR HP 5385A

Description:

A signal generator is connected through a power splitter to the HP 5385A channel B input and to a power meter. The signal generator is varied over the frequency range, maintaining the specified signal level. The counter should display the correct frequencies.

Specifications:

- 15 mV rms (-23.5 dBm) sinewave, 90 MHz to 100 MHz
- 10 mV rms (-27 dBm) sine wave, 100 MHz to 1000 MHz

- a. 90 MHz to 100 MHz
1. Connect the signal generator and the power meter to the HP 5385A channel B input as shown in Figure 4-4.

NOTE

There shall be no cabling between the HP 11667A Power Splitter and the HP 5385A channel B input or between the power splitter and the power sensor.

VOLTAGE	dBm EQUIVALENT
6.5 mV	-30.73 dBm
7.0 mV	-30.09 dBm
8.0 mV	-28.93 dBm
9.0 mV	-27.90 dBm
10.0 mV	-26.99 dBm
12.0 mV	-25.41 dBm
15.0 mV	-23.47 dBm

HP 8640B/OPT 002 SIGNAL GENERATOR

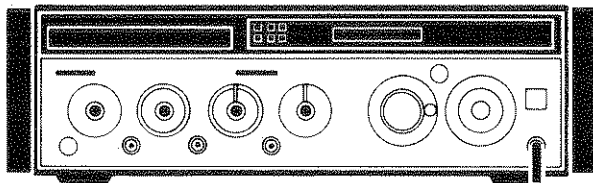

RF OUTPUT

HP 5385A
FREQUENCY COUNTER

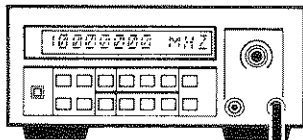

INPUT B

TYPE "N"
ADAPTER
1250-0082

HP 8491A
ATTENUATOR
(-6 dB PAD)

TYPE "N"
ADAPTER
1250-0780

BNC CABLE

TYPE "N"
ADAPTER
1250-0780

HP 11667A
POWER SPLITTER

HP 436A POWER METER

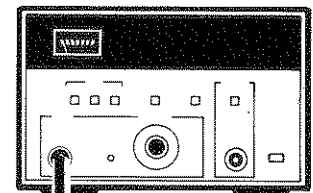

SENSOR

HP 8481A
POWER SENSOR

Figure 4-4. Channel B Frequency Response and Sensitivity Test Setup for HP 5385A

Table 4-1. Performance Test (Continued)

2. Set the HP 8640B Signal Generator so the HP 436A Power Meter reads -17.5 dBm at 90 MHz. Increase the frequency of the signal generator while maintaining a -17.5 dBm reading on the power meter. Verify the HP 5385A displays an increase in frequency, approximately tracking the signal generator from 90 MHz to 100 MHz. Record the results on the test card (Pass/Fail).
- b. 100 MHz to 1000 MHz
 1. Set the HP 8640B Signal Generator so the power meter reads -21 dBm at 100 MHz. Increase the frequency of the signal generator while maintaining a -21 dBm reading on the power meter, and verify the HP 5385A displays the proper frequencies from 100 MHz to 1000 MHz. Record the results on the test card (Pass/Fail).

V. PERIOD A TEST

Description:

A signal generator with a calibrated output drives channel A of the HP 5384A/HP 5385A under test. The counter is set to measure the period of the signal. The HP 5384A/HP 5385A should display the proper count.

Specifications: 10 nanoseconds to 0.1 seconds (100 MHz to 10 Hz)

- a. Connect the HP 3325A synthesizer/function generator to the HP 5384A/HP 5385A Channel A input as shown in Figure 4-5.

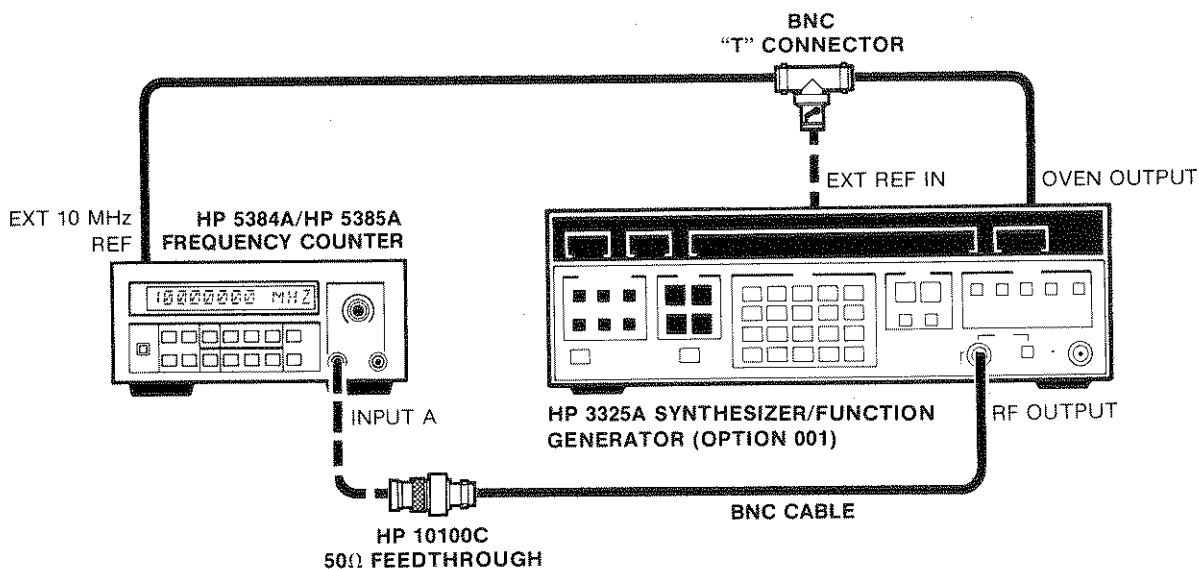

Figure 4-5. Period A Test Setup

- b. Set the counter power switch from STBY to ON and select PERIOD A. Set the GATE time to 1.0 seconds.
- c. Set the HP 3325A synthesizer to 10 Hz at 100 mV rms output.
- d. Verify the counter displays 100.00000 milliseconds ± 70 microseconds. Record the results on the test card (pass/fail).

VI. CHANNEL A FILTER AND ATTENUATOR TEST

Description:

A signal generator with a calibrated output drives the channel A of the HP 5384A or HP 5385A under test. The counter is set up for its Frequency A function, and the channel A filter is exercised at frequencies below and above its normal 3 dB point. The channel A attenuator is also exercised. The counter should display the proper frequencies.

Table 4-1. Performance Test (Continued)

Specifications:

Low Pass Filter, 100 kHz, nominal at 3 dB point.
X1 or X20, nominal, selectable.

Perform the following steps to use the Channel A Filter and Attenuator tests.

- a. Set the counter POWER switch from STBY to ON; set the gate time to 1.0 seconds.
- b. Connect the HP 3325A Synthesizer/Function Generator to the HP 5384A/HP 5385A Channel A input as shown in Figure 4-6.

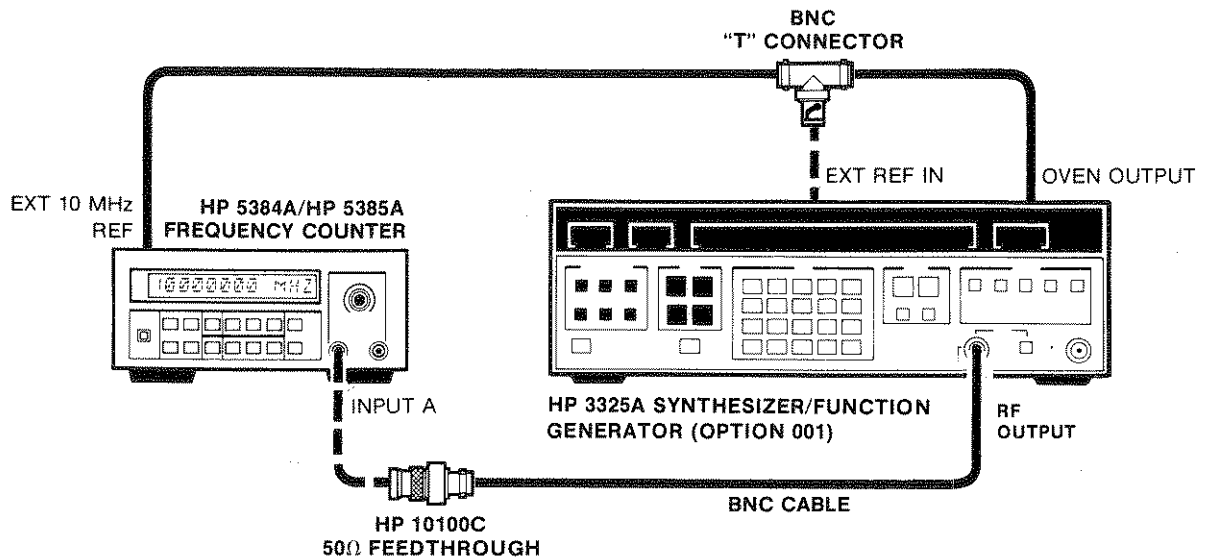

Figure 4-6. Channel A Filter and Attenuator Test Setup

- c. Press the 1 second gate time Key.
- d.
 1. Set the HP 3325A to output a 50 kHz sinewave at 15 mV rms.
 2. Verify that the counter displays 50.0000000K \pm 3 millihertz, with a continuous indication above "A" and a flashing indicator above "GATE" on the front panel.
 3. Enable the channel A FILTER function; observe that the HP 5384A/HP 5385A display has not changed and an indicator arrow appears in the display above the "FILT" label on the front panel.
 4. Disable the FILTER function.
- e.
 1. Set the HP 3325A to output a 1 MHz sinewave at 55 mV rms.
 2. Verify counter displays "1.00000000M" \pm 10 millihertz
 3. Enable the channel A FILTER function; observe that the counter displays all zeros.
 4. Disable the FILTER function and observe that the counter displays 1.00000000 MHz \pm 10 millihertz.
 5. Record the results on the test card (Pass/Fail).
- f.
 1. Enable the channel A X20 ATTENUATOR; observe the HP 5384A/HP 5385A display showing eight zeros with indicators above "ATTN" and "A" only. Disable the X20 ATTN function, and observe the counter displaying the same value as in step e. Record the results on the test card (pass/fail).

PERFORMANCE TEST RECORD

HEWLETT-PACKARD MODEL 5384A/5385A FREQUENCY COUNTER		Repair/Work Order No. _____
Serial Number: _____		Temperature: _____
Test Performed By: _____		Relative Humidity: _____
Date: _____		Post Calibration Test: <input type="checkbox"/>
Notes: _____		Pre Calibration Test: <input type="checkbox"/>

PARA. NO.	TEST	CORRECT DISPLAY	RESULTS		
			YES	NO	
I.	POWER-UP SELF CHECK "Starburst" Displayed All Positions Selected Address Displayed 8 Zeroes Arrow Over "A" Channel Displayed	"Starburst" "SELECTED ADDRESS" 00000000 Δ	_____	_____	
			_____	_____	
			_____	_____	
			_____	_____	
II.	CHANNEL A FREQUENCY RESPONSE AND SENSITIVITY TEST (HP 5384A/85A) 10 Hz - 50 Hz @ 25 mV rms 50 Hz - 20 MHz @ 15 mV rms 20 MHz - 100 MHz @ 15 mV rms	Stable Count Stable Count Stable Count	_____	_____	
			_____	_____	
			_____	_____	
			_____	_____	
III.	CHANNEL B FREQUENCY RESPONSE AND SENSITIVITY TEST (HP 5384A) 50 MHz - 200 MHz @ 10 mV rms 200 MHz - 225 MHz @ 15 mV rms	Stable Count Stable Count	_____	_____	
			_____	_____	
			_____	_____	
			_____	_____	
IV.	CHANNEL B FREQUENCY RESPONSE AND SENSITIVITY TEST (HP 5385A) Display, 90 MHz - 100 MHz @ -17.5 dBm 100 MHz - 1000 MHz @ -21 dBm	Stable Count Stable Count	_____	_____	
			_____	_____	
			_____	_____	
			_____	_____	
V.	PERIOD A TEST Counter Displays 100.00000 milliseconds		MINIMUM	ACTUAL	MAXIMUM
			99.93000	_____	100.07000
VI.	CHANNEL A FILTER AND ATTENUATOR TEST FILTER Off Enable FILTER FILTER Off Enable FILTER — Counter Displays All Zeroes Disable FILTER Enable X20 ATTENUATOR Counter Displays all zeroes	50.0000000K Δ Flashing Arrow above GATE 1.00000000M 00000000 1.00000000M 00000000	_____	_____	
			_____	_____	
			_____	_____	
			_____	_____	
			_____	_____	
			_____	_____	
			YES	NO	

SECTION V ADJUSTMENTS

5-1. INTRODUCTION

5-2. This section describes the adjustments required to maintain the HP 5384A/HP 5385A operating characteristics within specifications. Adjustments should be made when required, such as after a performance test failure or when components are replaced that may affect an adjustment.

5-3. *Table 5-1* lists the adjustment procedures, in the recommended order of performance, and indicates the adjustable components involved.

5-4. EQUIPMENT REQUIRED

5-5. The test equipment required for the adjustment procedures is listed in *Table 1-4*, Recommended Test Equipment. Substitute instruments may be used if they meet the critical specifications.

5-6. ADJUSTMENT LOCATIONS

5-7. Adjustment locations are identified in the procedure for each adjustment.

5-8. SAFETY CONSIDERATIONS

5-9. This section contains warnings that must be followed for your protection and to avoid damage to the instrument.

WARNING

MAINTENANCE DESCRIBED HEREIN IS PERFORMED WITH POWER SUPPLIED TO THE INSTRUMENT AND PROTECTIVE COVERS REMOVED. SUCH MAINTENANCE SHOULD BE PERFORMED ONLY BY SERVICE-TRAINED PERSONNEL WHO ARE AWARE OF THE HAZARDS INVOLVED (FOR EXAMPLE, FIRE AND ELECTRICAL SHOCK), WHERE MAINTENANCE CAN BE PERFORMED WITHOUT POWER APPLIED, SHOULD BE REMOVED.

BEFORE ANY REPAIR IS COMPLETED, ENSURE THAT ALL SAFETY FEATURES ARE INTACT AND FUNCTIONING, AND THAT ALL NECESSARY PARTS ARE CONNECTED TO THEIR PROTECTIVE GROUNDING MEANS.

Table 5-1. Adjustments

ASSEMBLY	ADJUSTMENT	COMMENTS
A1 Motherboard	A1R77	HP 5384A/HP 5385A +3 Vdc Adjustment
A1 Motherboard	A1R43	HP 5384A/HP 5385A Channel A Input Amplifier Adjustment
A1 Motherboard	A1R32	HP 5384A Channel B Input Amplifier Adjustment
A1 Motherboard	A1R34	HP 5385A Channel B Input Amplifier Adjustment
A1 Motherboard	A1C65 A1C66	Standard Oscillator Adjustment
A1 Motherboard	Y1B	2 TCXO Oscillator Adjustment
A1 Motherboard	Y1A	Oven Oscillator Adjustment
A3 Battery Chg	A3R26	Fast Charge Threshold Adjustment
A3 Battery Chg	A3R25	Fast Charge Current Adjustment

5-10. HP 5384A/HP 5385A ADJUSTMENT PROCEDURES

5-11. HP 5384A/HP 5385A +3 Volt dc Adjustment Procedure

5-12. The only voltage supply in the HP 5384A and HP 5385A that requires adjustment is the +3 Volts. To perform this adjustment, proceed as follows:

- a. Switch the counter from STBY to ON.
- b. Connect the positive terminal of the DVM to TP1 and the negative terminal to chassis ground at the ac input power connector in the rear of the counter.
- c. Adjust A1R77 for a DVM reading of 3.00 Volts, ± 30 mV.
- d. Switch the counter from ON to STBY. Disconnect the test equipment.

**5-13. HP 5384A/HP 5385A Channel A Input
Amplifier Adjustment Procedure**

5-14. To perform the sensitivity adjustment, proceed as follows:

- a. Remove the HP 5384A/HP 5385A top and bottom covers; locate variable resistor A1R43 as shown in *Figure 5-1*, Assembly Adjustment Locator.
- b. Cycle the power switch from STBY to ON. Allow 30 minutes warm-up time.
- c. Connect the HP 8656A Signal Generator as shown in *Figure 5-2*.
- d. Set the HP 8656A to output a 10 MHz sinewave at 10 mV rms.

e. Connect the scope probe at the junction of A1R19 and A1R65E. See *Figure 5-1* for probe connection point.

f. Adjust A1R43 for a 50/50 duty cycle. Refer to the waveform in *Figure 5-3*.

g. Vary the frequency of the signal generator from 10 MHz to 100 MHz, and verify that the counter shows a stable display throughout.

h. Connect a suitable generator (such as the HP 3325A) to input A that can provide a 25 mV rms sine wave between 10 Hz and 50 Hz. Vary the generator frequency between 10 Hz and 50 Hz and verify that the displayed counts are stable.

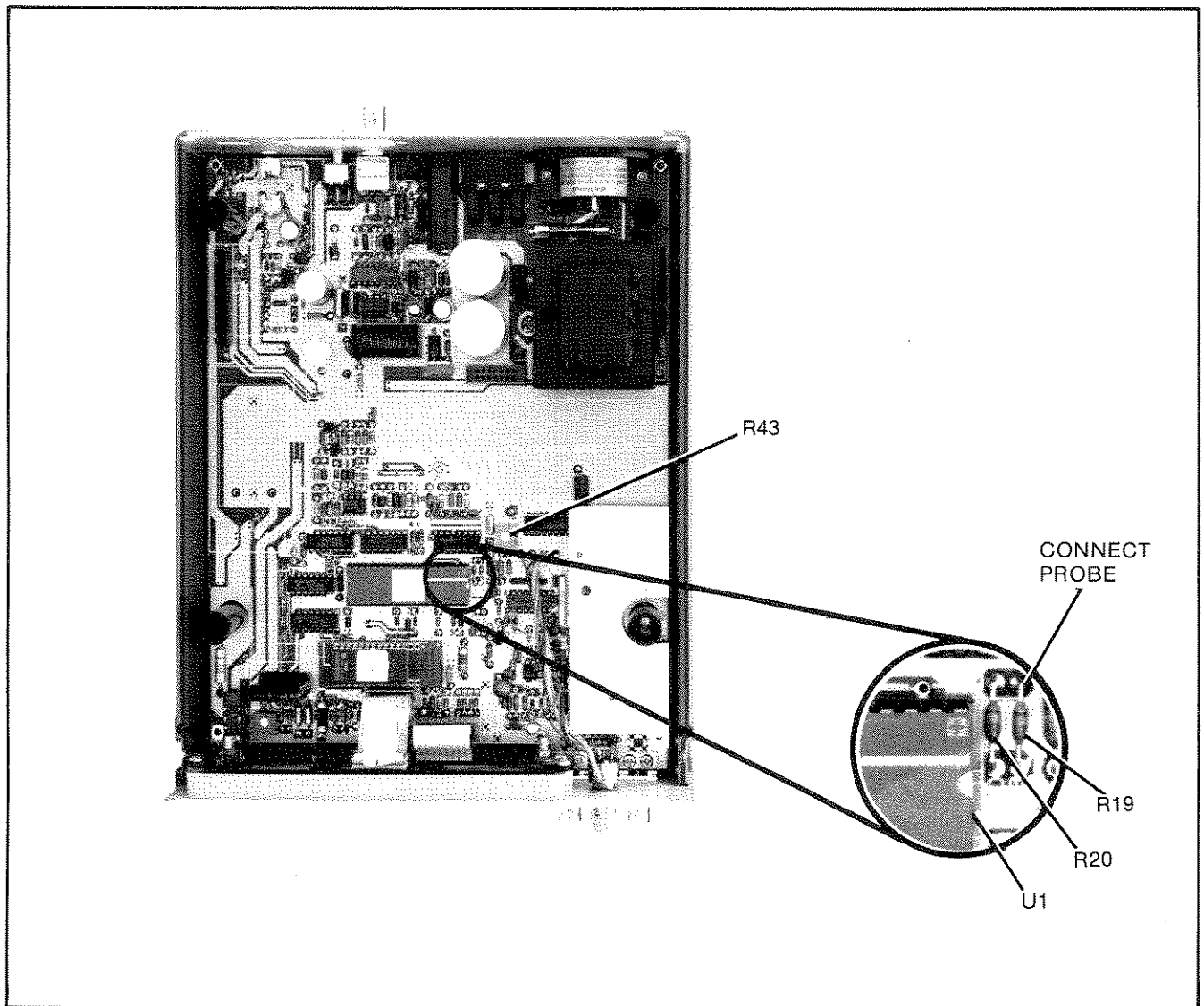

Figure 5-1. Assembly Adjustment Locator

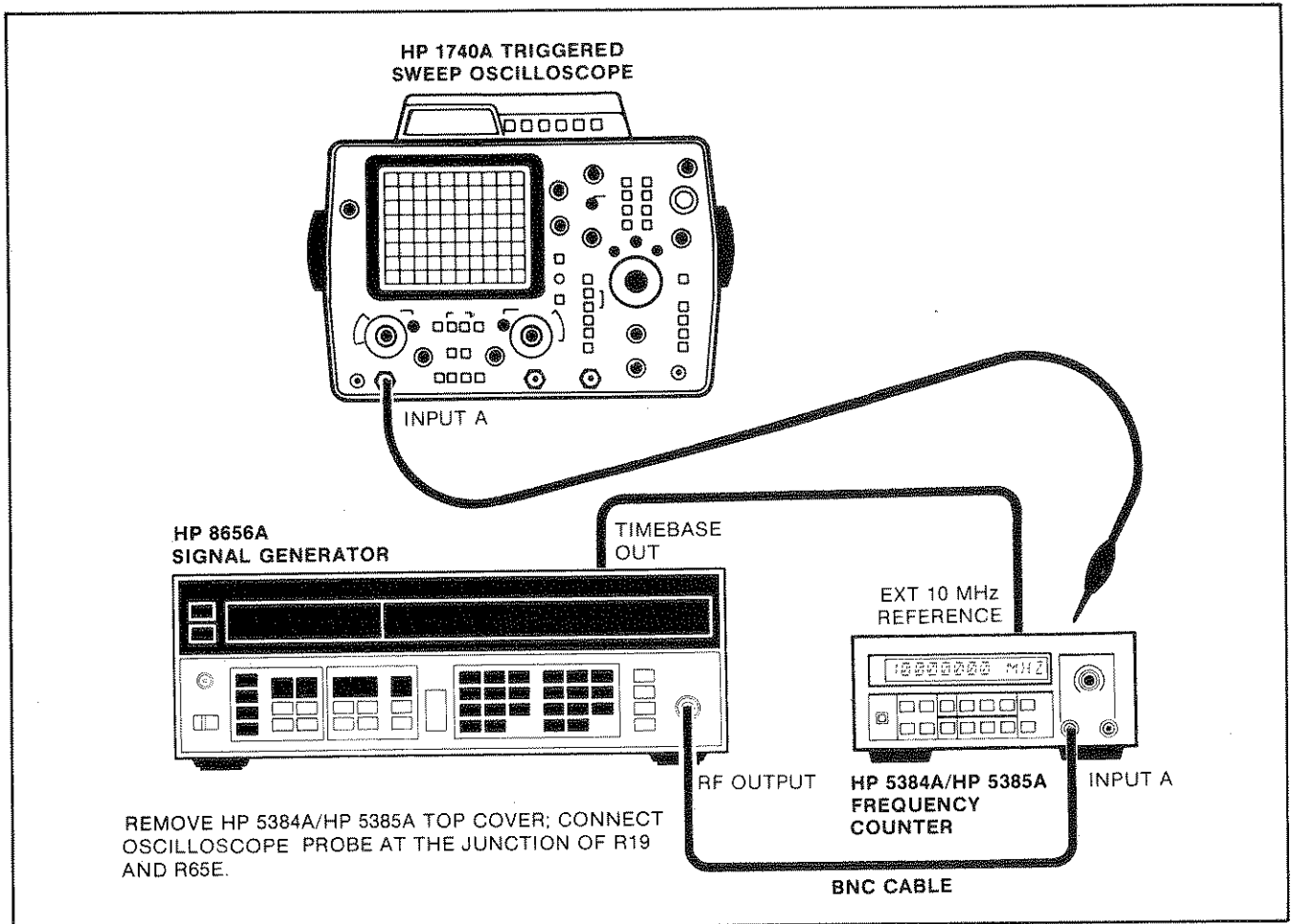

Figure 5-2. Channel A Input Amplifier Adjustment Setup

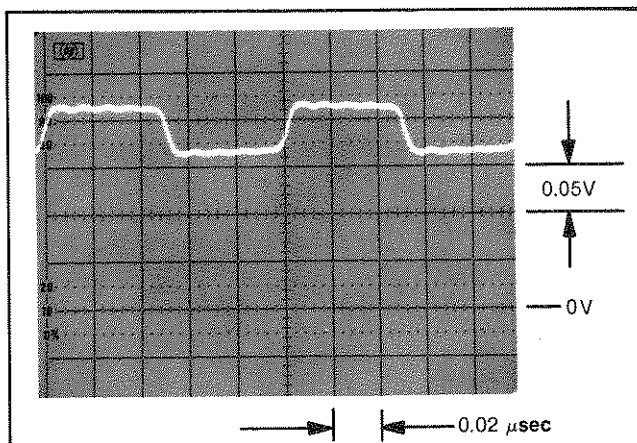

Figure 5-3. Input Amplifier Adjustment Waveform

5-15. HP 5384A Channel B Input Amplifier Adjustment Procedure

5-16. To perform the sensitivity adjustment proceed as follows:

a. Connect the HP 8656A Signal Generator as shown in Figure 5-4.

b. Cycle the power switch from STBY to ON and press the **FREQ B** button on the HP 5384A front panel.

c. Set the HP 8656A to output a 200 MHz sinewave at 6 mV rms. Adjust A1R32 for a stable display count. Vary the frequency from 200 MHz to 50 MHz and verify that the counter shows a stable display.

d. This completes the adjustment for Channels A and B; switch the counter to STBY and disconnect all test equipment.

5-17. HP 5385A Channel B Input Amplifier Adjustment Procedure

5-18. To perform the sensitivity adjustments, proceed as follows:

a. Cycle the power switch from STBY to ON. Press **FREQ B** button on the front panel.

b. Locate variable resistor A1R34 on the A1 Motherboard. Refer to the A1 component locator in Section VIII.

c. Connect instruments as shown in Figure 5-5.

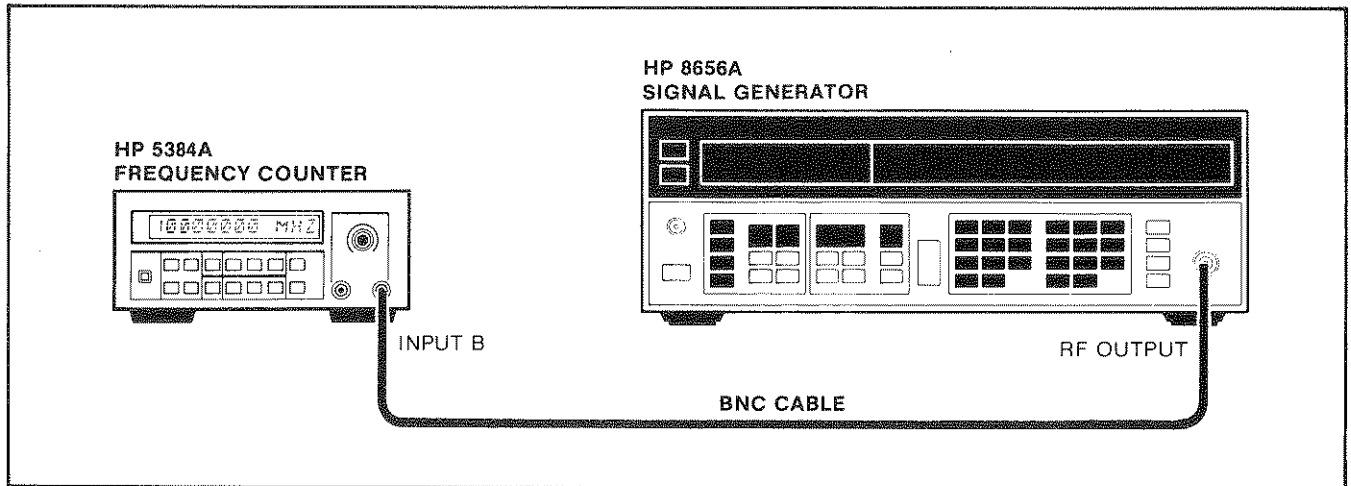

Figure 5-4. HP 5384A Channel B Input Amplifier Adjustment Setup

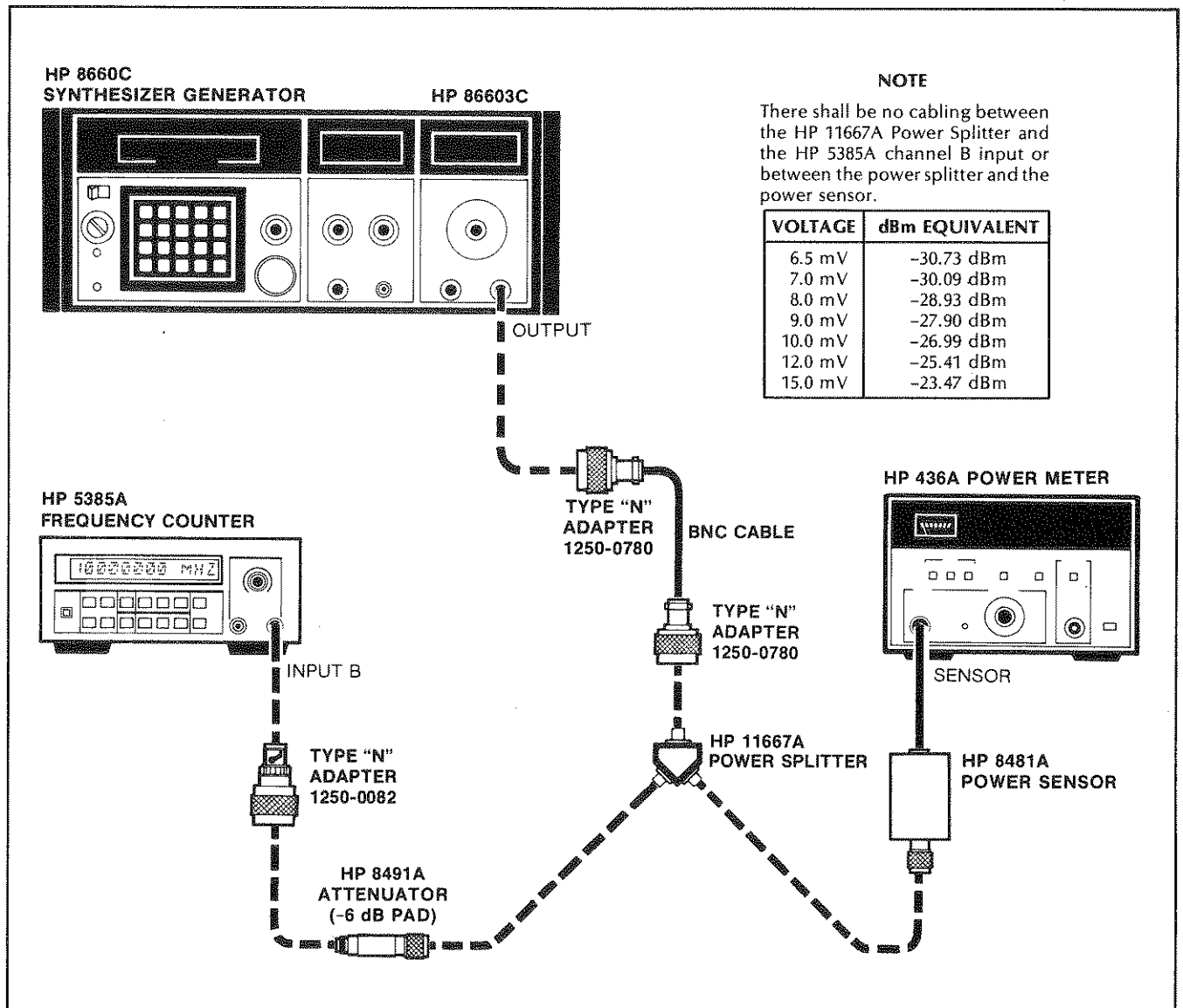

Figure 5-5. HP 5385A Channel B Input Amplifier Adjustment Setup

d. Set HP 8660C to output a 100 MHz sinewave, varying the HP 86603A vernier until the HP 436A power Meter reads -24 dBm, ± 0.3 dBm. Adjust A1R34 for a stable display of 100.00000 MHz, ± 10 Hz.

e. Vary the frequency range from 90 MHz to 1000 MHz and verify the HP 5385A displays the correct count.

f. Turn the HP 5385A and the HP 8660C off and disconnect all test equipment.

5-19. Standard Oscillator Adjustment Procedures

5-20. The procedure used for adjusting the standard oscillator is the same as the procedure used for adjusting the TCXO at 25°C described in paragraph 5-23. Refer to paragraph 5-23 for adjustment procedure.

5-21. TCXO Adjustment Procedure

5-22. Two procedures are given for the adjustment of the TCXO (Temperature compensated Crystal Oscillator). If the operation of the counter will be solely at 25°C (77°F), then adjust the oscillator frequency as close as possible to 10 MHz using the procedure in paragraph 5-23. If the operation of the counter will be over the full temperature range (0°C to 40°C) then the TCXO must be offset by the amount

labeled on its cover to keep the TCXO frequency within the manufacturers frequency specifications over the temperature range of 0°C to 40°C. In this case use the procedure in paragraph 5-28. The TCXO is factory set for use near 25°C.

5-23. Adjustment of the TCXO at 25°C

NOTE

Allow 30 minutes warm-up time for the counter.

a. Connect a house standard (reference frequency) to the EXT TRIGGER input of an HP 1740A Oscilloscope as shown in Figure 5-6. Set the HP 1740A oscilloscope to EXT (trigger).

b. Connect the HP 5384A/HP 5385A rear panel 10 MHz REFERENCE IN OUT to the channel A input of the HP 1740A oscilloscope as shown in Figure 5-6.

c. Select INT with the 10 MHz REFERENCE IN EXT select switch on the rear of the instrument (see Figure 5-7).

d. Adjust the frequency for minimum sideways movement of the 10 MHz signal with the OSC ADJ located on the rear of the instrument (see Figure 5-7). For the Standard Oscillator, the same rear panel location is used to adjust A1C66, the standard oscillator fine adjustment capacitor. If A1C66 does not have enough range to minimize movement, adjust

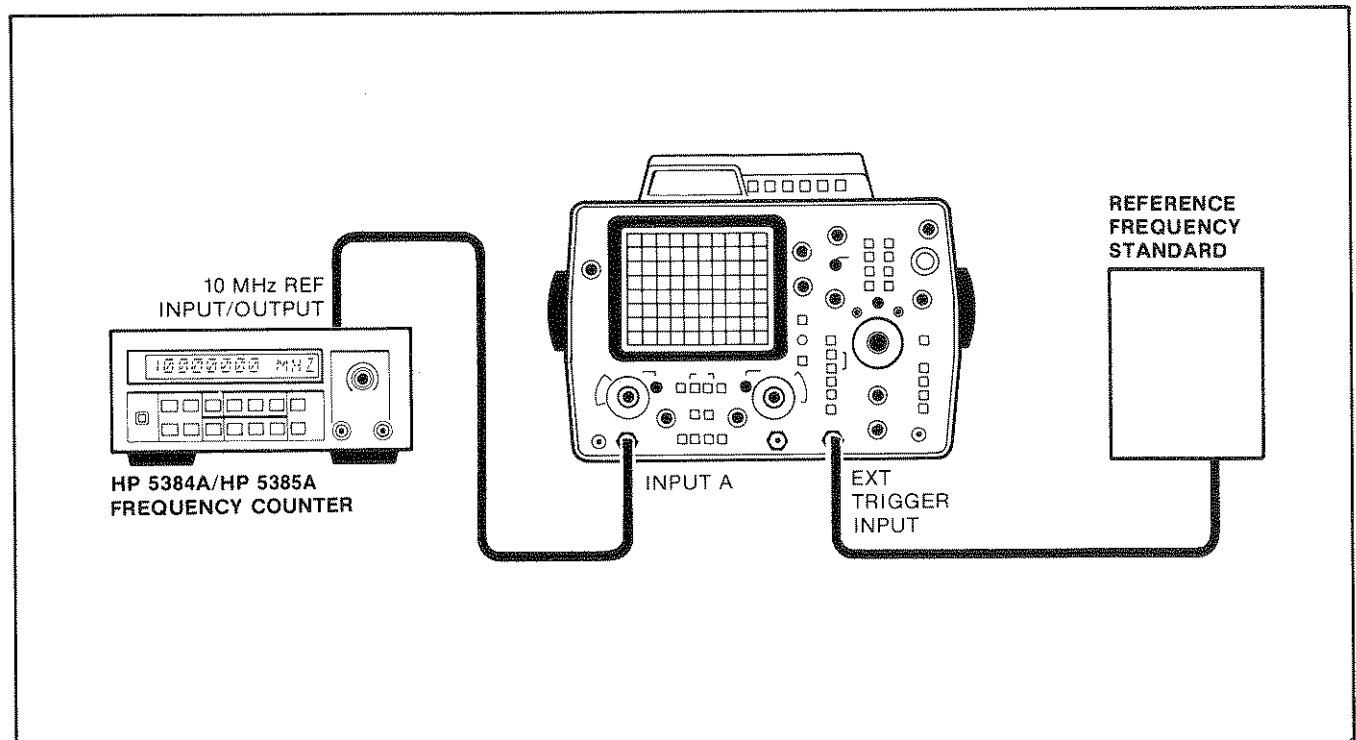

Figure 5-6. Standard, TCXO and Oven Oscillator Test Setup

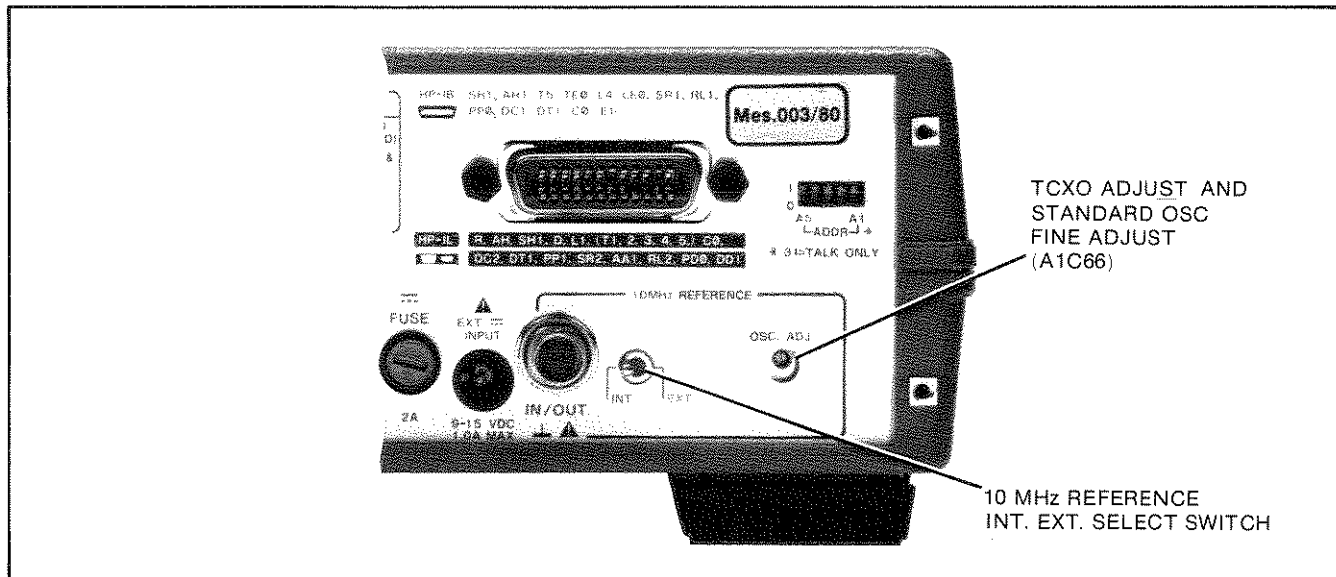

Figure 5-7. TCXO and Standard Oscillator Adjustment

A1C65 (coarse adjustment, see Figure 5-8 for location) until the display is close enough for adjustment with A1C66.

based on the HP 1740A oscilloscope sweep speed as shown in Table 5-2.

NOTE

For access to A1C65, remove the top cover. The interface board should not have to be removed to access and adjust A1C65. Remove the top cover by removing the 4 screws located at the bottom of the counter.

e. By timing the sideways movement (in cm/second), the approximate offset can be determined

Table 5-2. Approximate Offset Determination Table

MOVEMENT	SWEEP SPEED			NOTES
	1 μ s/cm	0.1 μ s/cm	0.01 μ s/cm	
1cm/s	1 \times 10 ⁻⁶	1 \times 10 ⁻⁷	1 \times 10 ⁻⁸	Time scope trace movement with second hand of watch or clock
1cm/10s	1 \times 10 ⁻⁷	1 \times 10 ⁻⁸	1 \times 10 ⁻⁹	
1cm/1000s	1 \times 10 ⁻⁸	1 \times 10 ⁻⁹	1 \times 10 ⁻¹⁰	

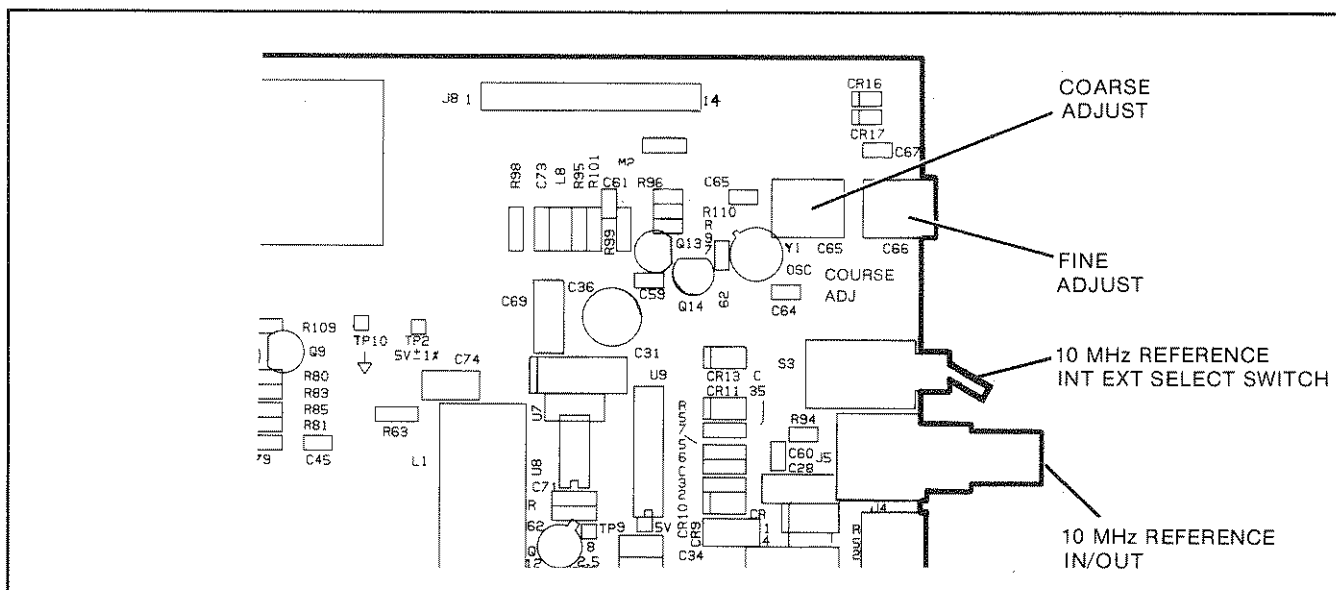

Figure 5-8. Standard Oscillator Coarse and Fine Adjustment Location

f. This completes the adjustment of the standard oscillator or the TCXO for use near 25°C.

5-24. Adjustment Of The TCXO With Offset (0° to 40°C):

a. To observe the offset stamped on the label of the TCXO, remove the top cover by removing the four screws located in the bottom half of the cabinet. For access to the two screws at the rear of the counter, remove the rear feet. Lift off the top.

b. Connect a house standard (reference frequency) to Channel A of the HP 5384A/HP 5385A as shown in Figure 5-6.

c. Cycle the HP 5384A/HP 5385A from STBY to ON. Press the DISPLAY DIGITS "up" (\blacktriangle) key once.

NOTE

Allow 30 minutes warm-up time for the counter.

d. Adjust the TCXO frequency to 10 MHz \pm the offset labeled on the TCXO. For example, if the offset is +3.5 Hz (3.5 Hz above 10 MHz), then the TCXO should be adjusted so the 10 MHz input frequency appears to be 9.9999965 MHz (which is 3.5 Hz below the TCXO frequency) on the counter display at a room temperature of 25°C.

e. Reinstall the covers; the TCXO offset adjustment is completed.

5-25. Oven Oscillator Adjustment Procedure

a. Remove the top cover by removing the four screws located in the bottom half of the cabinet. (For access to the two screws at the rear of the counter, remove the rear feet.) Lift off the top.

b. The HP 5384A/HP 5385A should now be allowed to operate for at least 30 minutes before proceeding with the oscillator adjustment.

c. Connect a house standard (reference frequency) to the EXT TRIGGER input of an HP 1740A oscilloscope as shown in Figure 5-6. Set the 1740A Oscilloscope to External Trigger.

d. Connect the HP 5384A/HP 5385A rear panel 10 MHz REFERENCE IN OUT to the Channel A input of the HP 1740A oscilloscope as shown in Figure 5-6.

e. Turn the adjustment screw on the oven oscillator for minimum sideways movement of the signal on the oscilloscope.

f. By timing the sideways movement (in cm/second), the approximate offset can be determined based on the HP 1740A oscilloscope sweep speed as shown in Table 5-2.

g. This completes the adjustment of the oven oscillator.

5-26. HP 5384A/HP 5385A Battery Charger Adjustment Procedure

5-27. The A3 battery charger board requires adjustment if U1, U2, or Q1 have been replaced.

5-28. To perform the battery charger adjustments, make the following preparations:

a. Remove the top cover and place to the right of the counter. Leave the battery charger circuit connected (via ribbon cable W2).

b. Disconnect A3B1 6-volt battery from the circuit by removing A3W1 and A3W2 from the battery.

5-29. Fast Charge Current Adjustment:

a. Set the power STBY/ON switch to STBY. Connect the ac power plug to the rear of the instrument. Set A3R26 fully clockwise.

b. Connect the A3 battery charger to an HP 3465A voltmeter and 10 Ω , 20W resistor as shown in Figure 5-9.

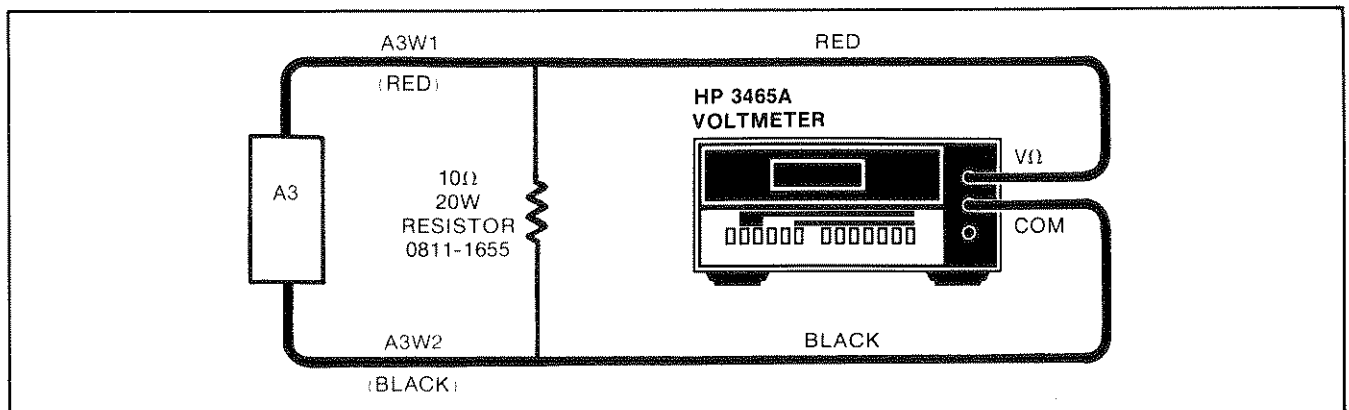

Figure 5-9. Fast Charge Current Adjustment Setup

HP 5384A and HP 5385A
Adjustments

c. Adjust A3R25 for a DVM reading of 5 volts ± 0.5 volts; A3R25 may be fully clockwise.

d. Set the counter STBY/ON switch to ON; observe the DVM reading to be approximately 90 mV ± 10 mV. Set the switch back to STBY.

5-30. Fast Charge Threshold Adjustment:

a. Connect the HP 5384A/HP 5385A as shown in Figure 5-10.

b. Set A3R26 fully counterclockwise. Set the HP 6237B Power Supply to its 18-volt range and adjust to 7 volts ± 10 mV.

c. Slowly adjust A3R26 clockwise while observing the ammeter on the HP 6237B Power Supply. Con-

tinue the clockwise adjustment until the ammeter drops to about 200 mA ± 100 mA.

d. Turn all test equipment off and disconnect the power cable from the counter. Disconnect the 10 ohm, 20 watt resistor.

e. Reconnect the A3 Charger board red and black battery wires. Observe proper polarity (red is positive, black is negative) and ensure the wire clips are fully engaged.

f. Replace the top cover. Ensure the four black plastic hold-down tubes, HP Part Number 4177-0236, are in place. As the cover is being positioned, ensure the W2 ribbon cable assembly will not be pinched between the top and bottom covers.

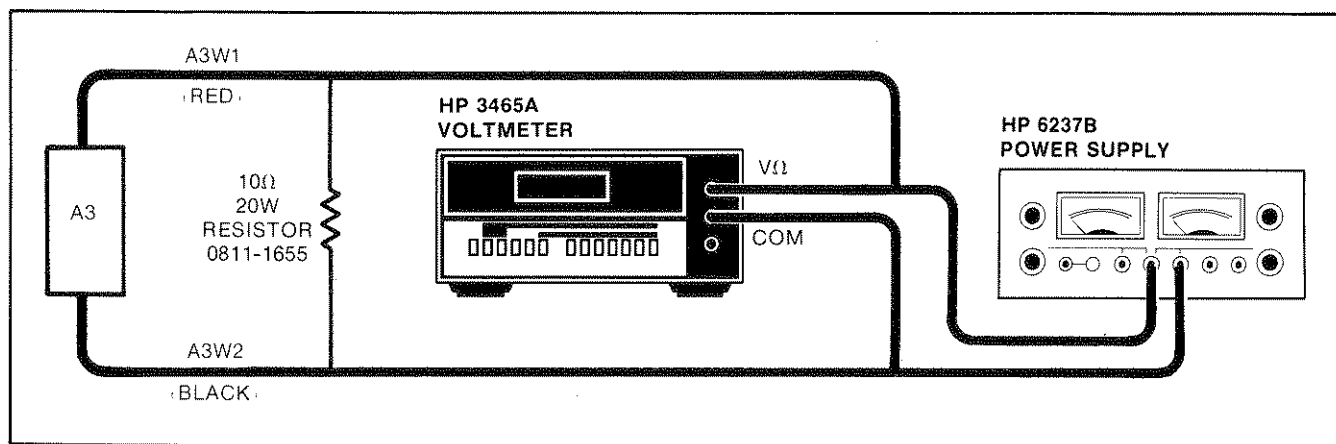

Figure 5-10. Fast Charge Threshold Adjustment Setup